



GardenBee™
BY DRIPWORKS

A COMPLETE GUIDE

START YOUR
GARDENING
JOURNEY

DRIPWORKS

dripworks.com



ABOUT US

At DripWorks GardenBee, our core ethos revolves around crafting natural, sustainable, and eco-conscious gardens. We take pride in catering to the needs of passionate landscapers and garden enthusiasts like you. Our mission is to introduce the finest Stainless Steel modular raised garden beds, designed to simplify the creation of beautiful gardens while ensuring an environmentally friendly approach.

These beds offer unparalleled advantages, including:

- **Hard metal panels will not be damaged by pests and mice**
- **Eco-friendly material**
- **Easy to assemble**
- **High tear resistance**
- **Long-lasting and durable: up to 20+ years**
- **High/low-temperature resistance: -148°F to 200°F**
- **Safe and no soil contamination**
- **Grow much more in much less space**



TABLES OF CONTENTS

1	Instruction Guide	1
2	Assembly Instruction	3
	9 in 1.....	3
	6 in 1.....	6
	4 in 1.....	8
	2 in 1.....	10
	Round	11
	Special Shapes.....	12
	Extension Kit.....	24
	Bracing Rods Placing.....	25

INSTRUCTION GUIDE

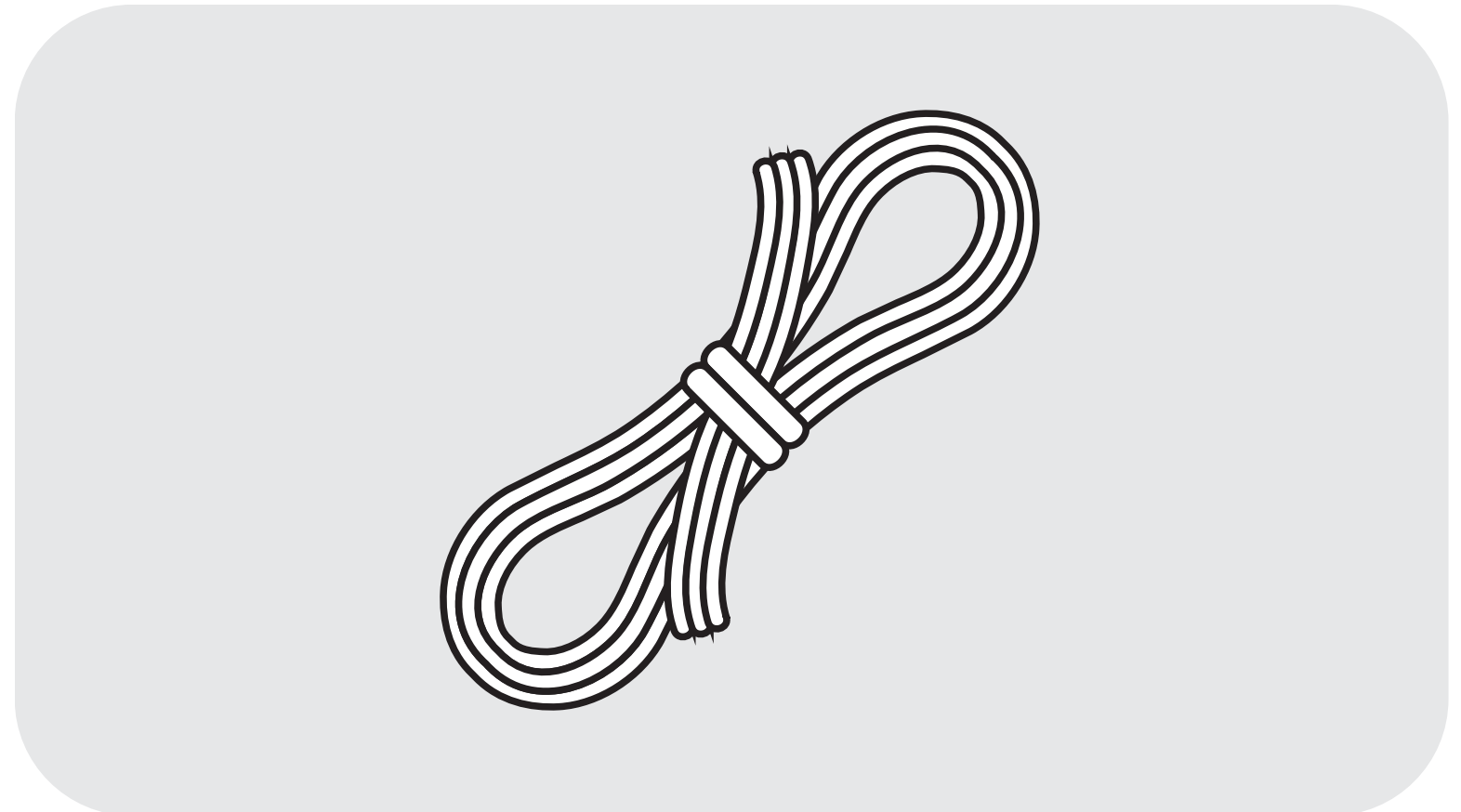
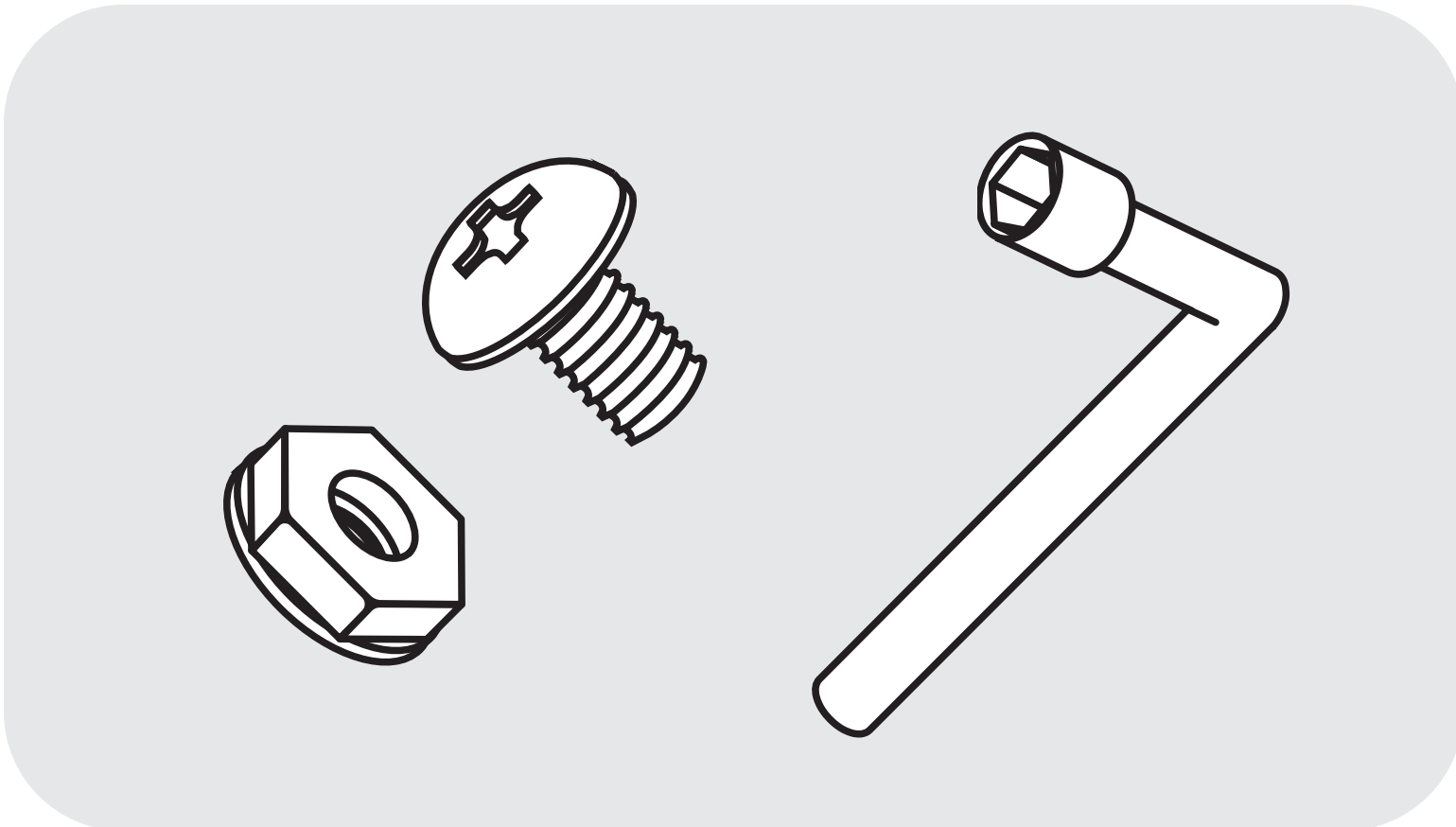

1.

Remove protective films.

2.

Keep holes aligned between two panels.



3.

Put the screws through the hole, place the washers(inside) and nuts. Use the wrench to tight up.

INSTRUCTION GUIDE

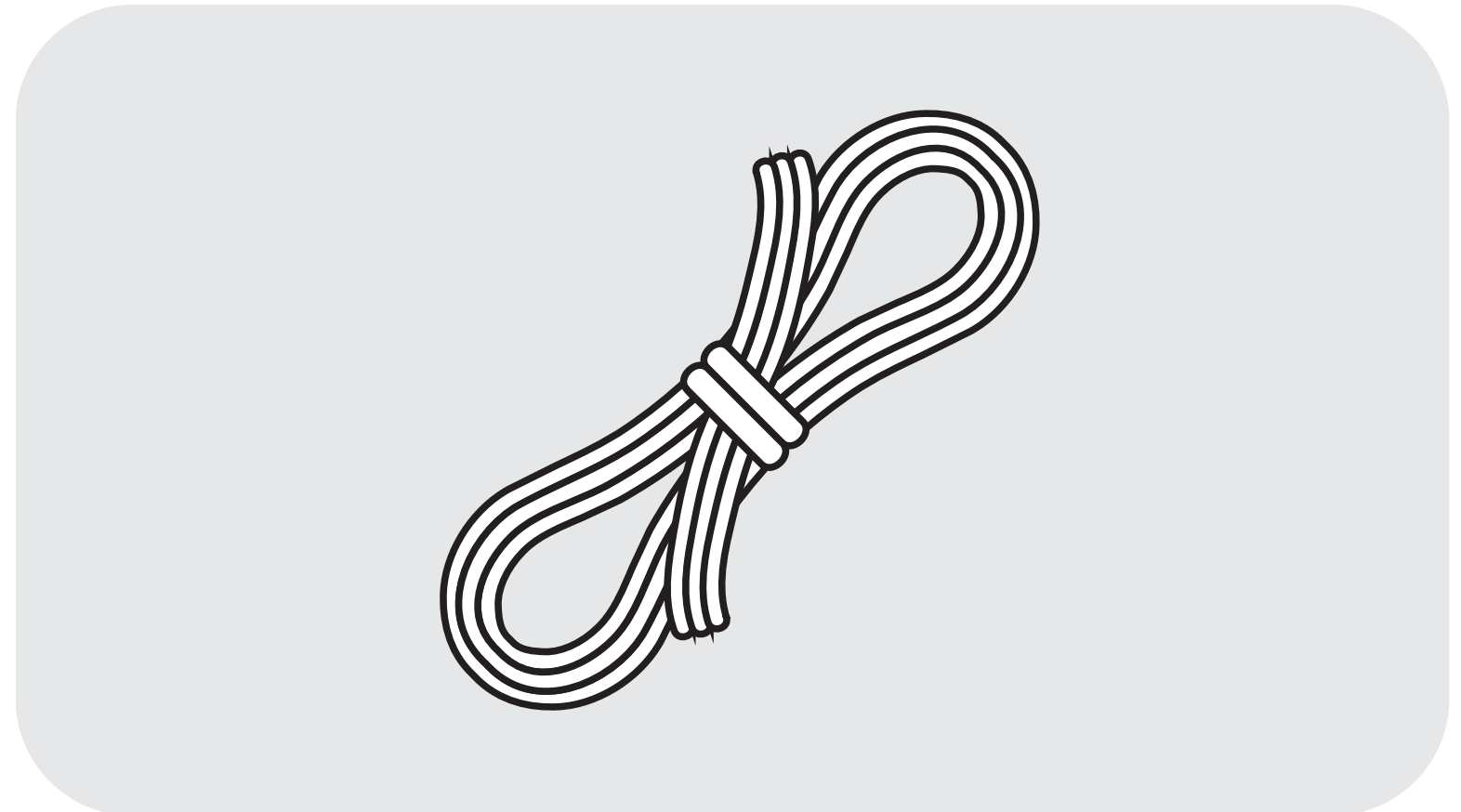
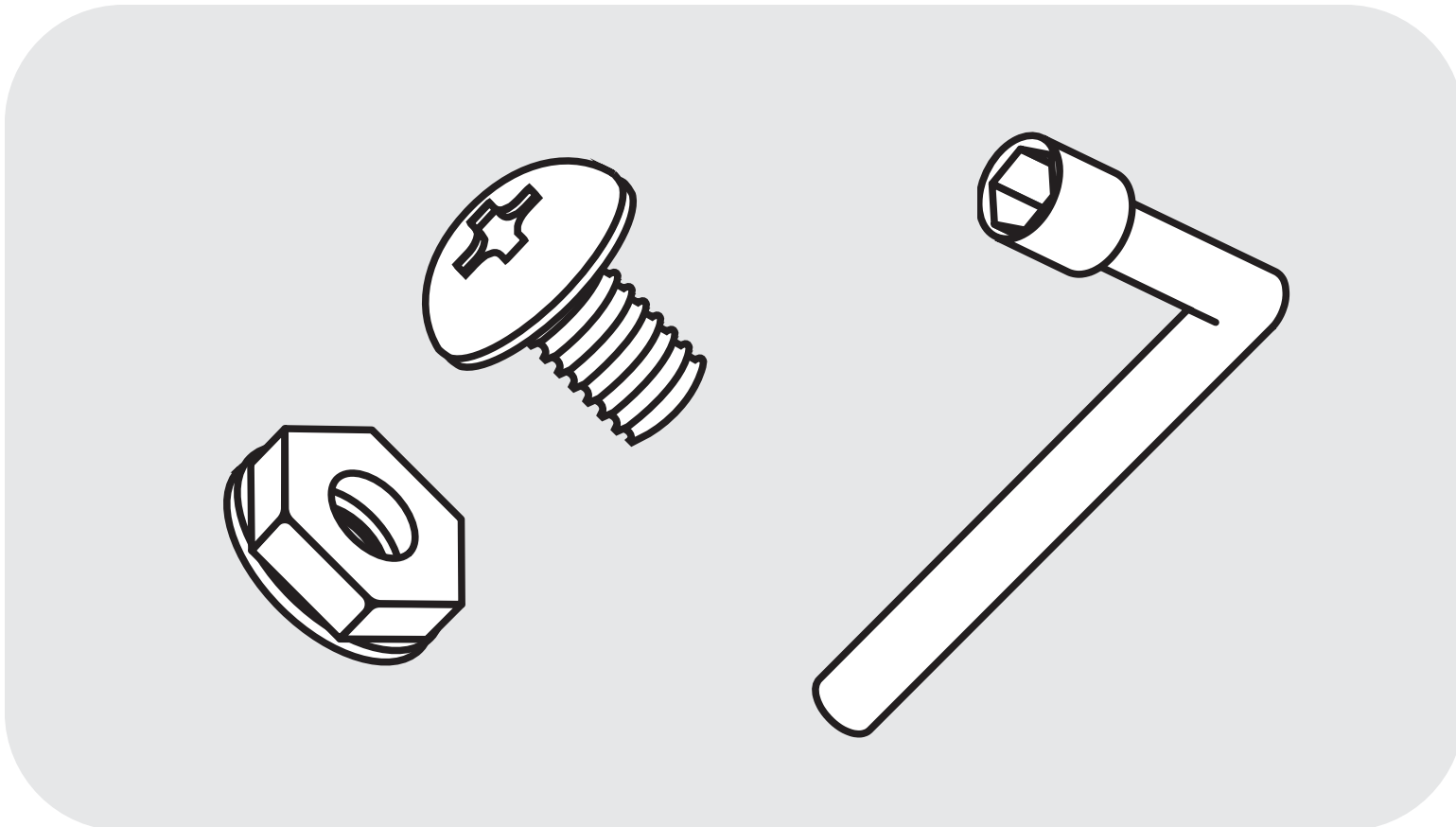

4.

Place the bracing rods. For more details on how to install the rods, please see Page 23.

5.

Apply protective rubber edging and push it down.



6.

 Done!

ASSEMBLY INSTRUCTION

9 in 1 Size: 8'x2'

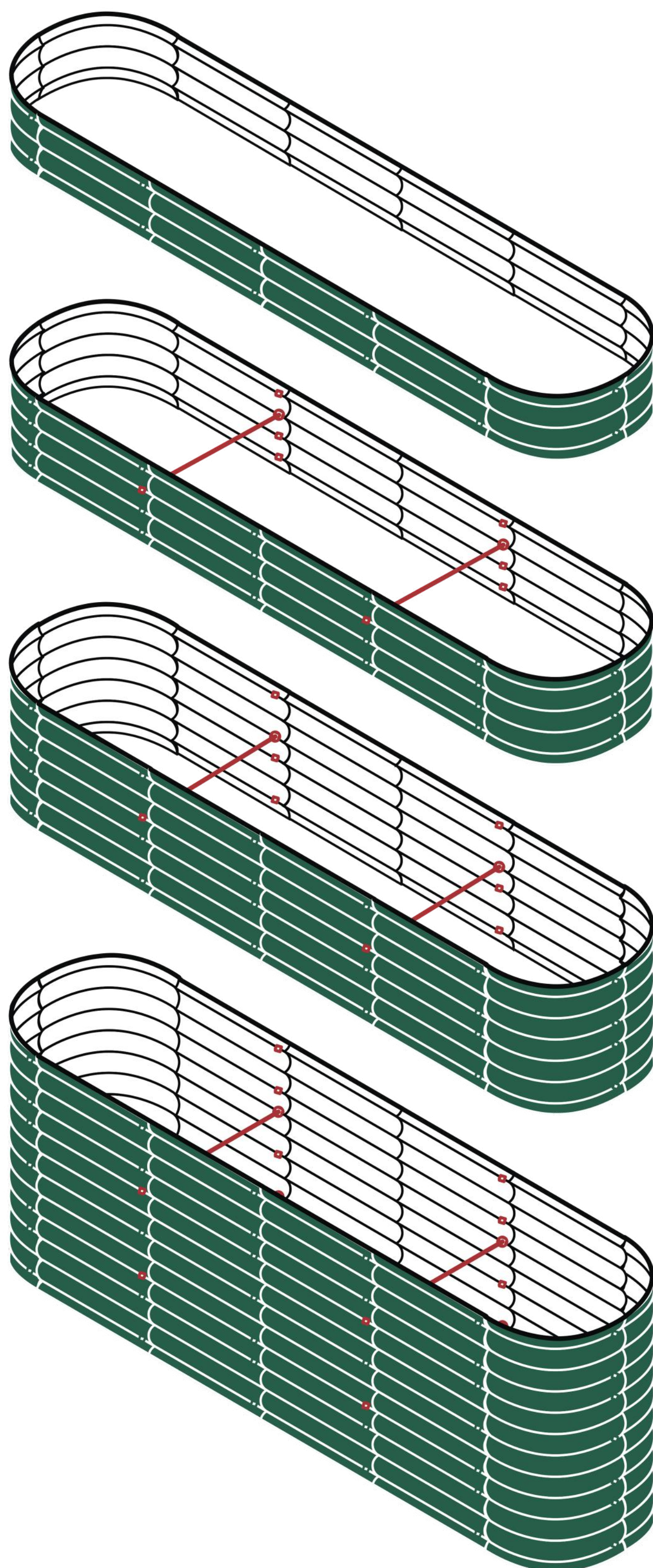
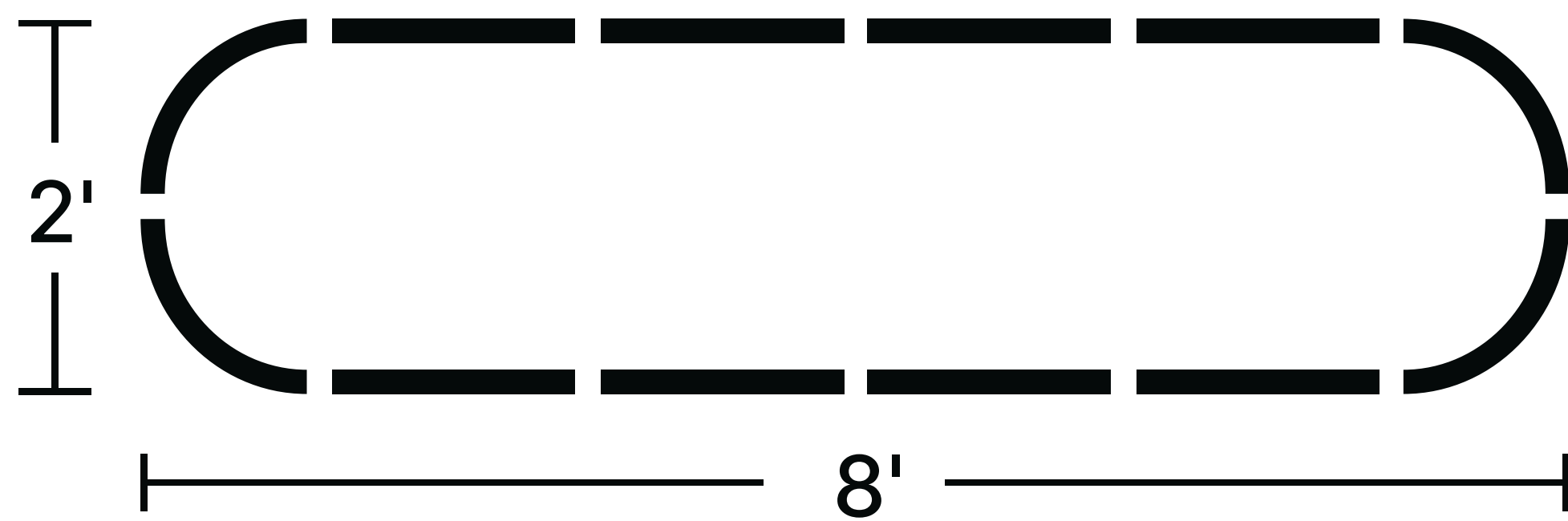

8"

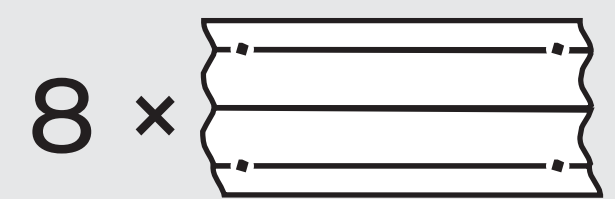
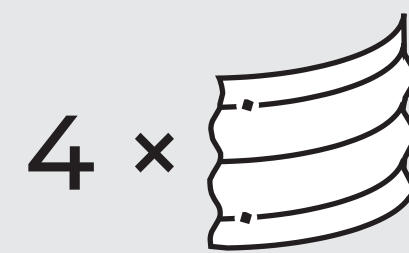

11"

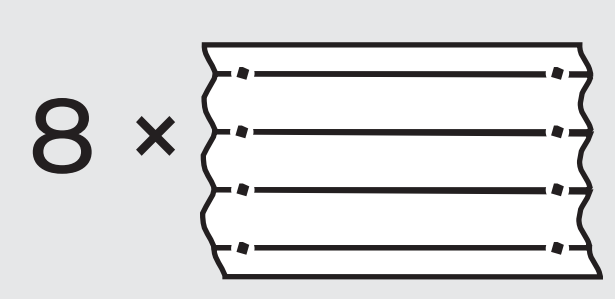
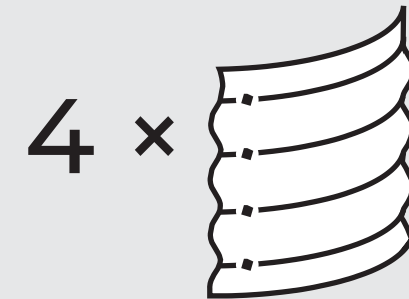

17"

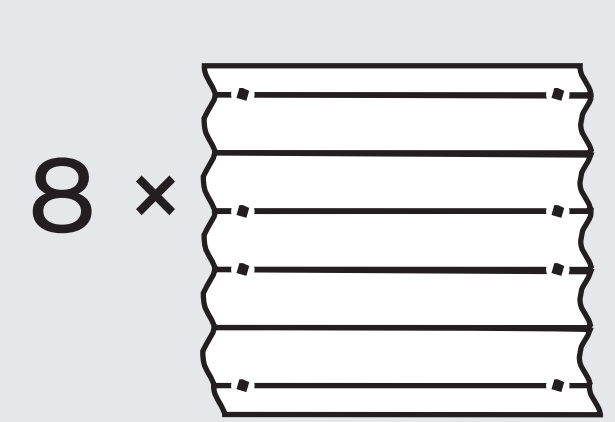

32"



ASSEMBLY INSTRUCTION

9 in 1 Size: 6.5'x3.5'

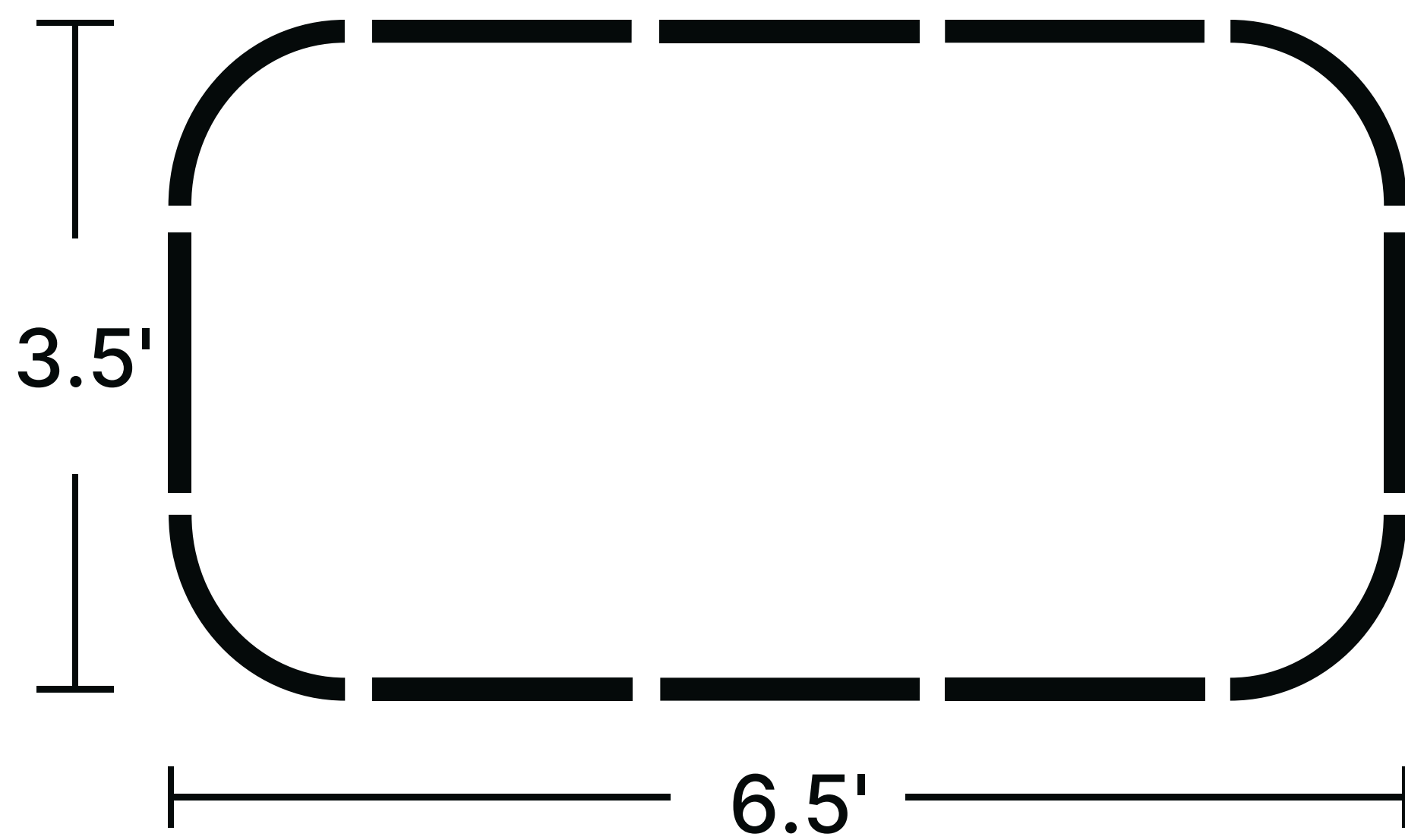

* 3.5ft rod is combined by one 2ft rod and one 1.5ft rod

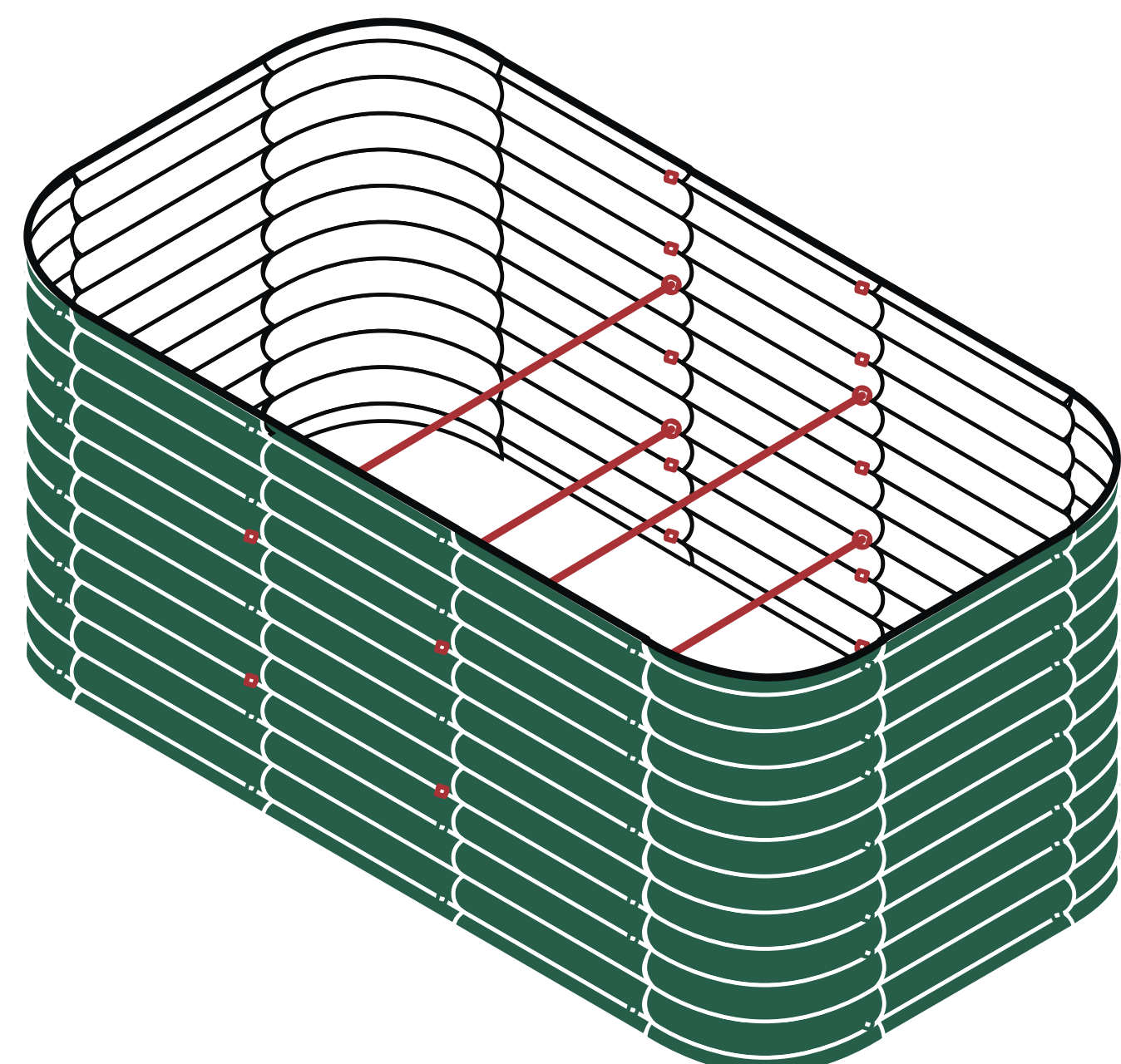
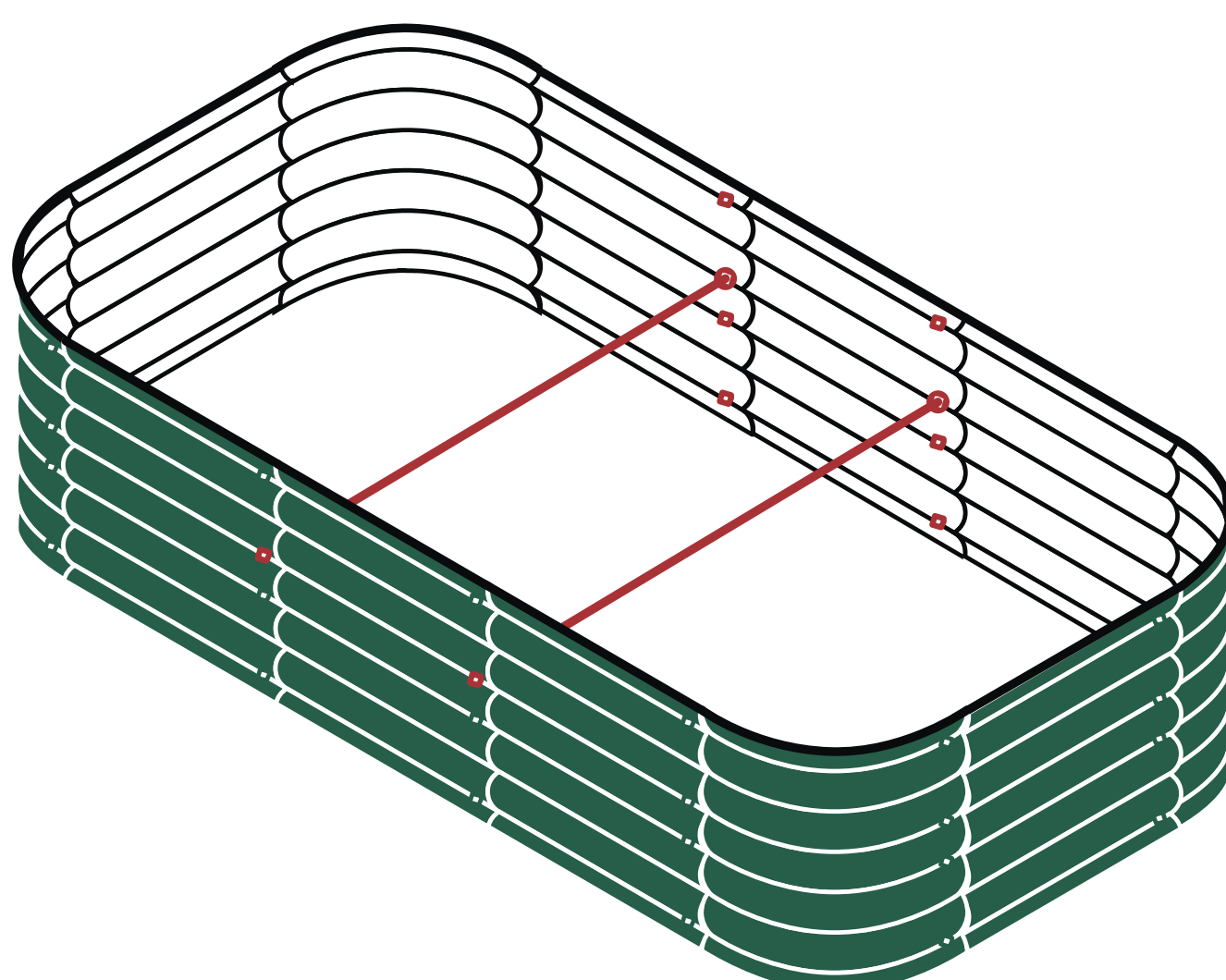
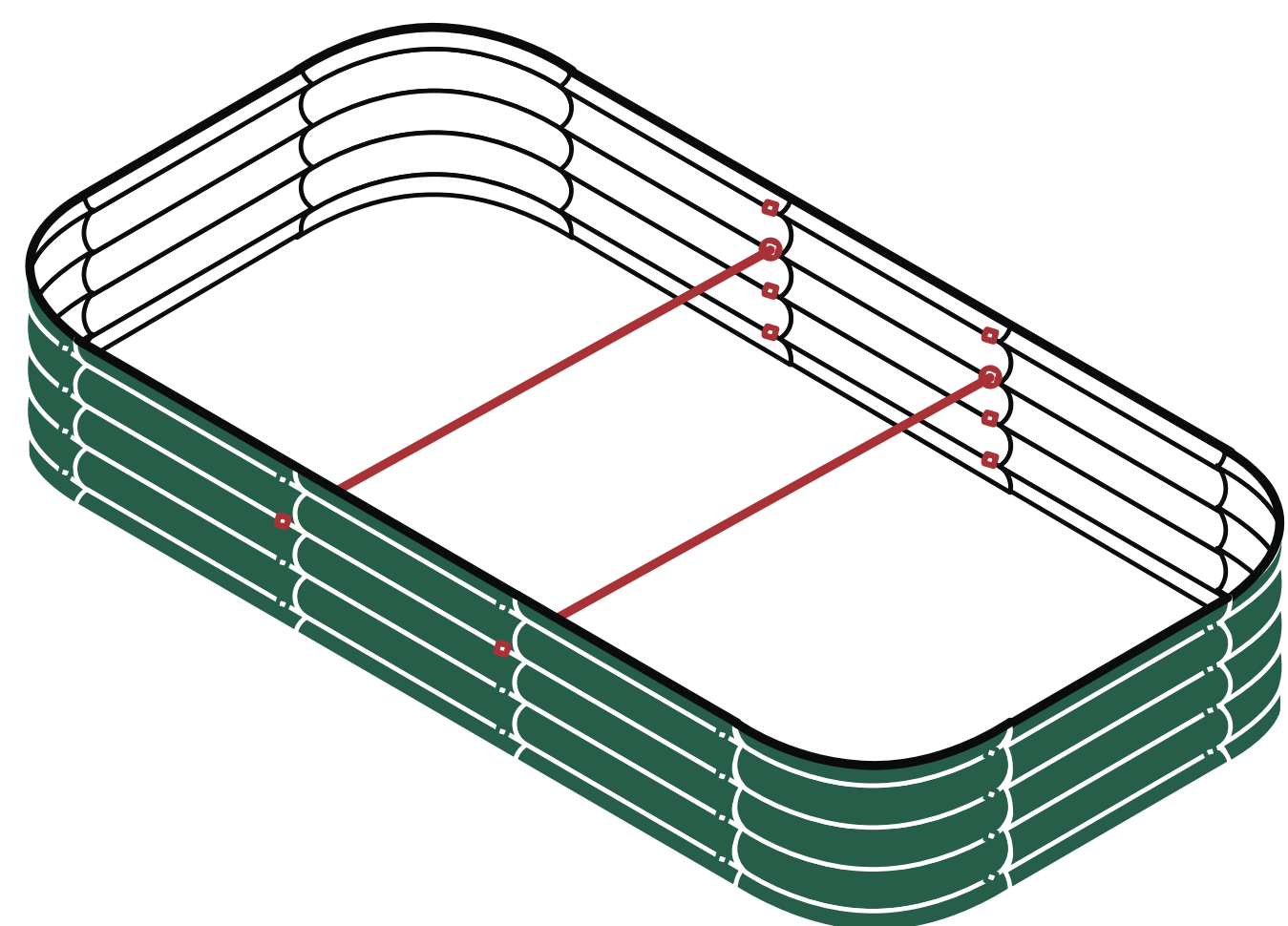
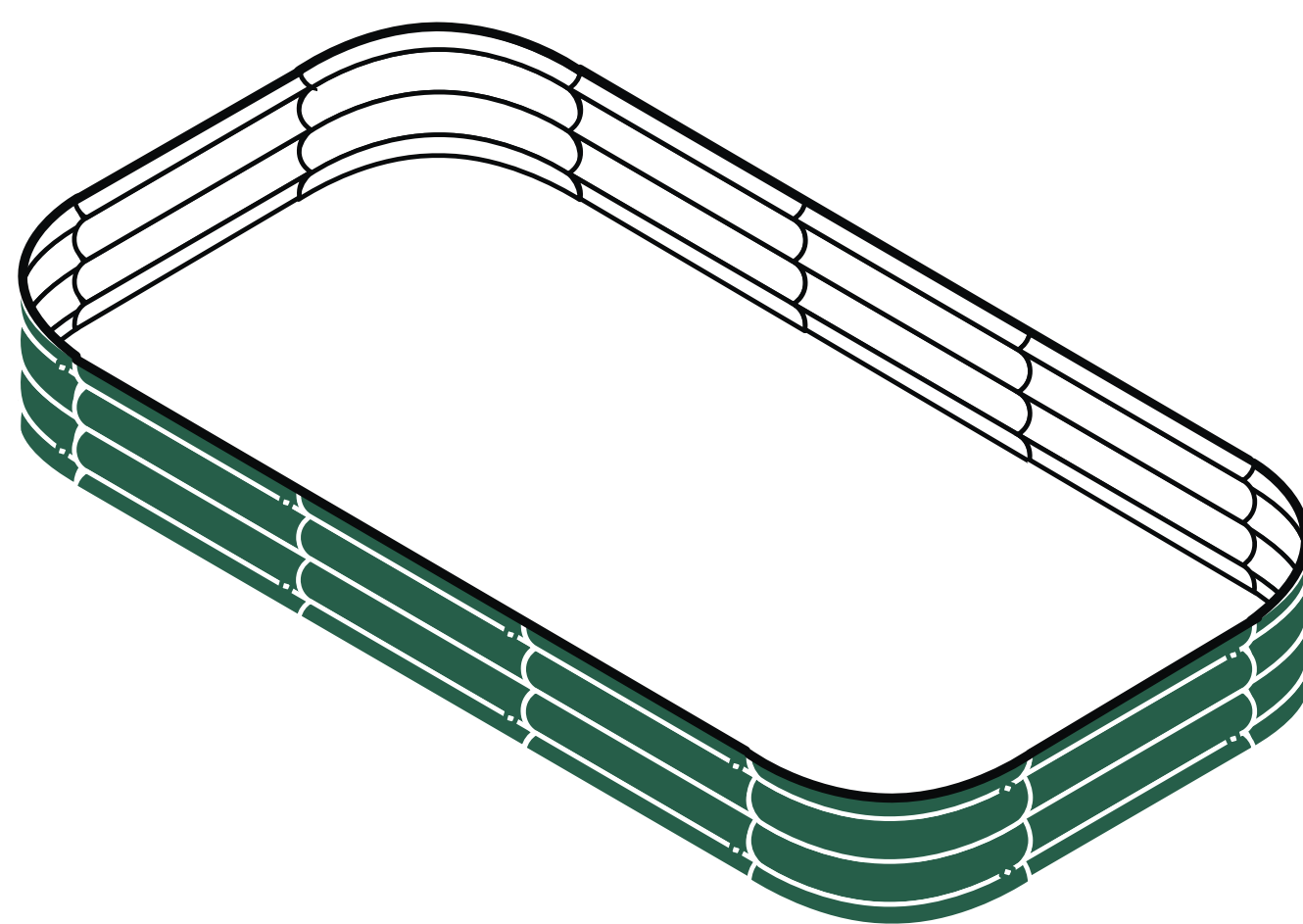
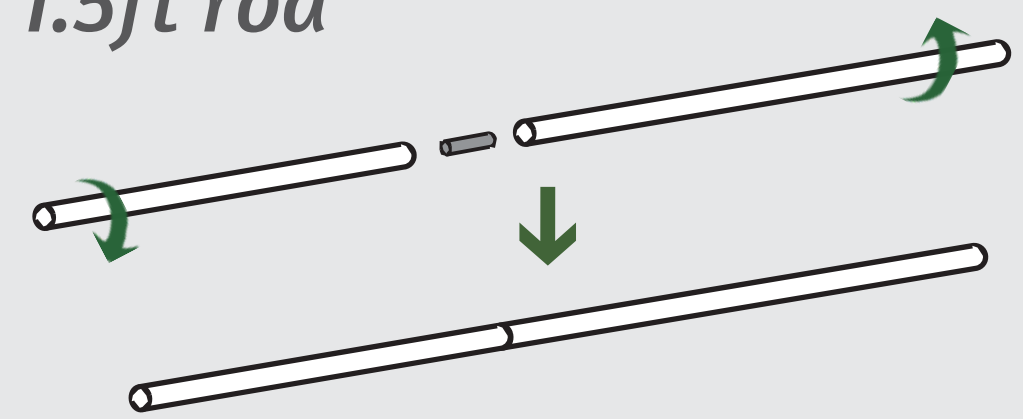

ASSEMBLY INSTRUCTION

9 in 1 Size: 5'x5'

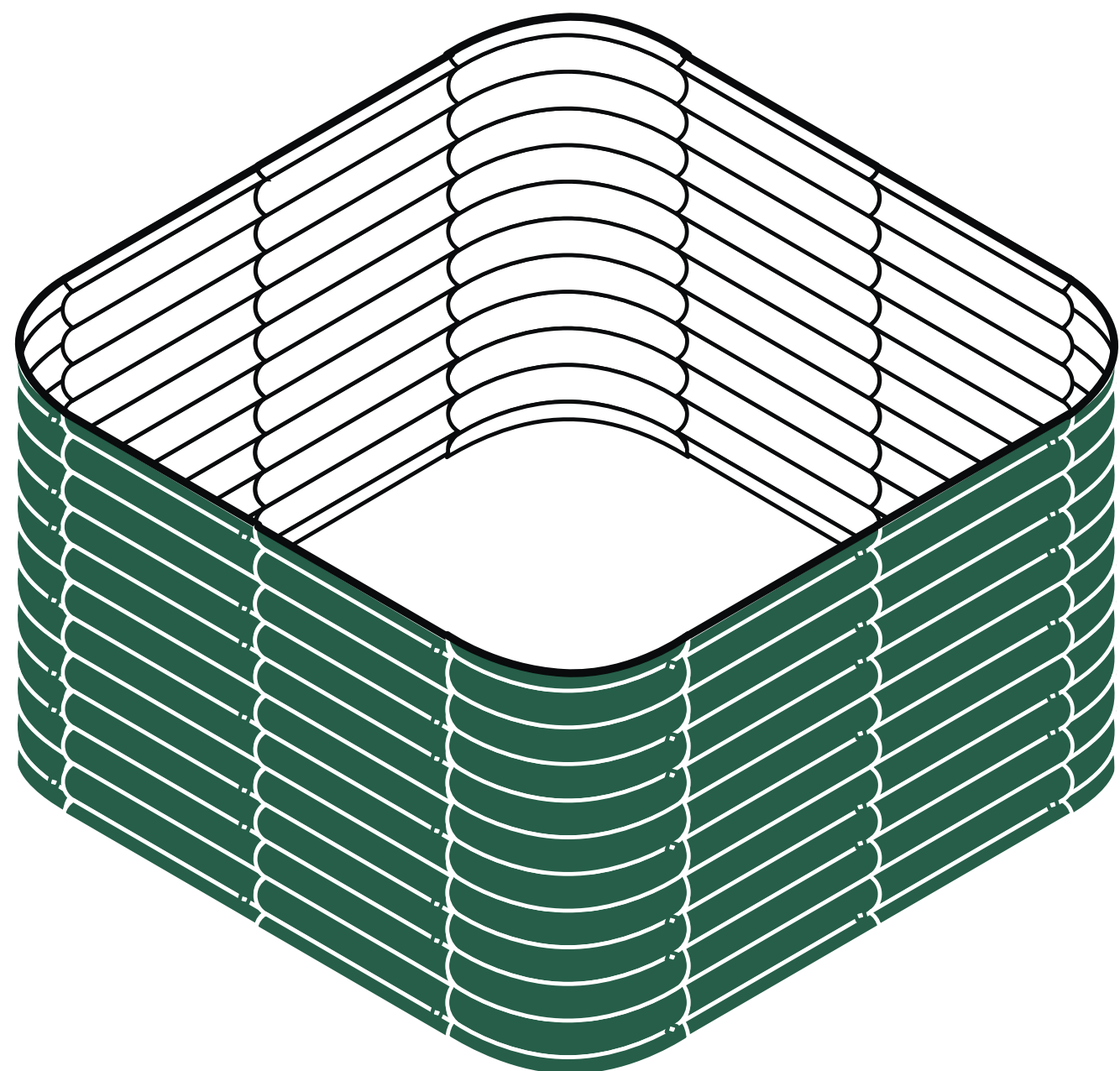
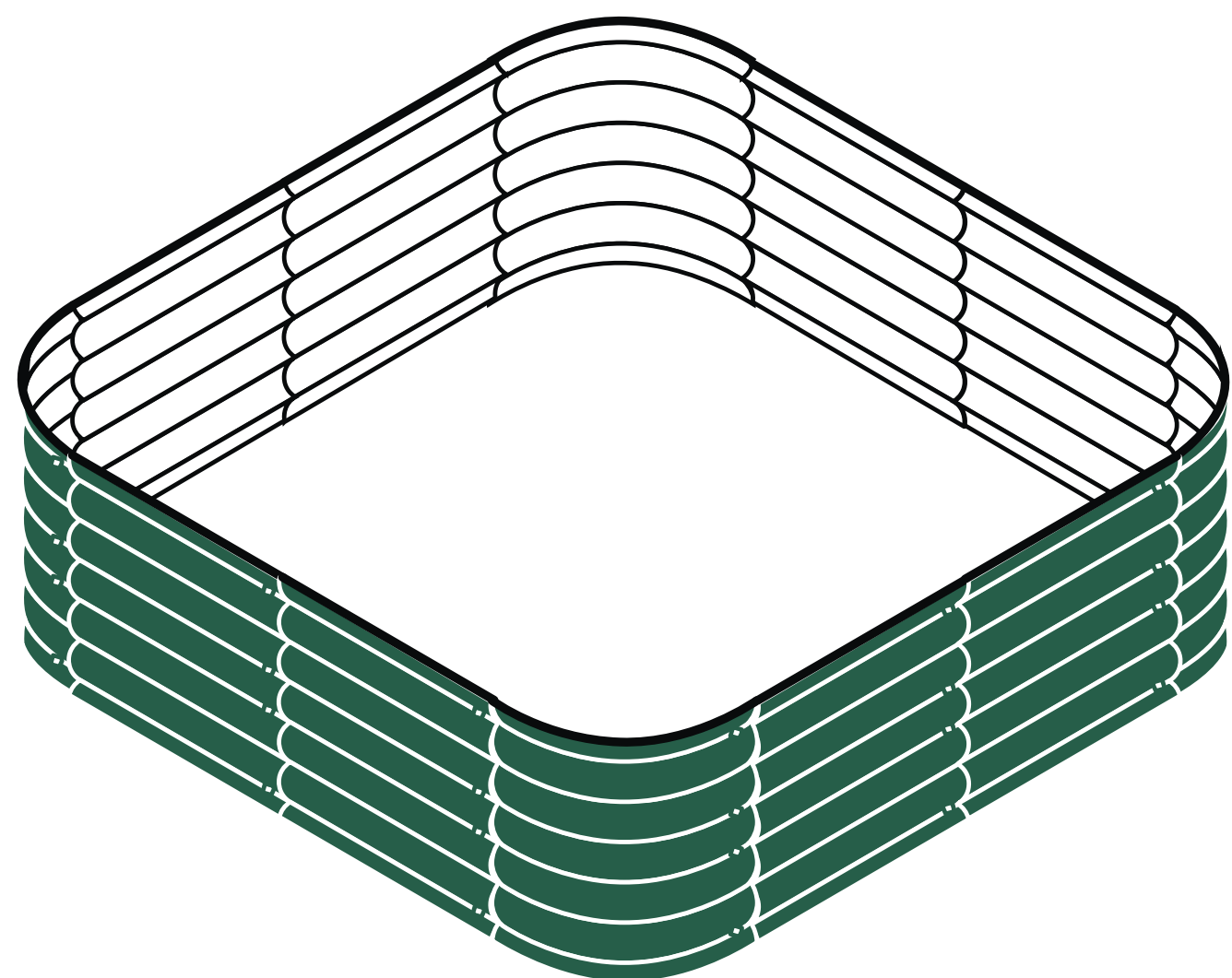
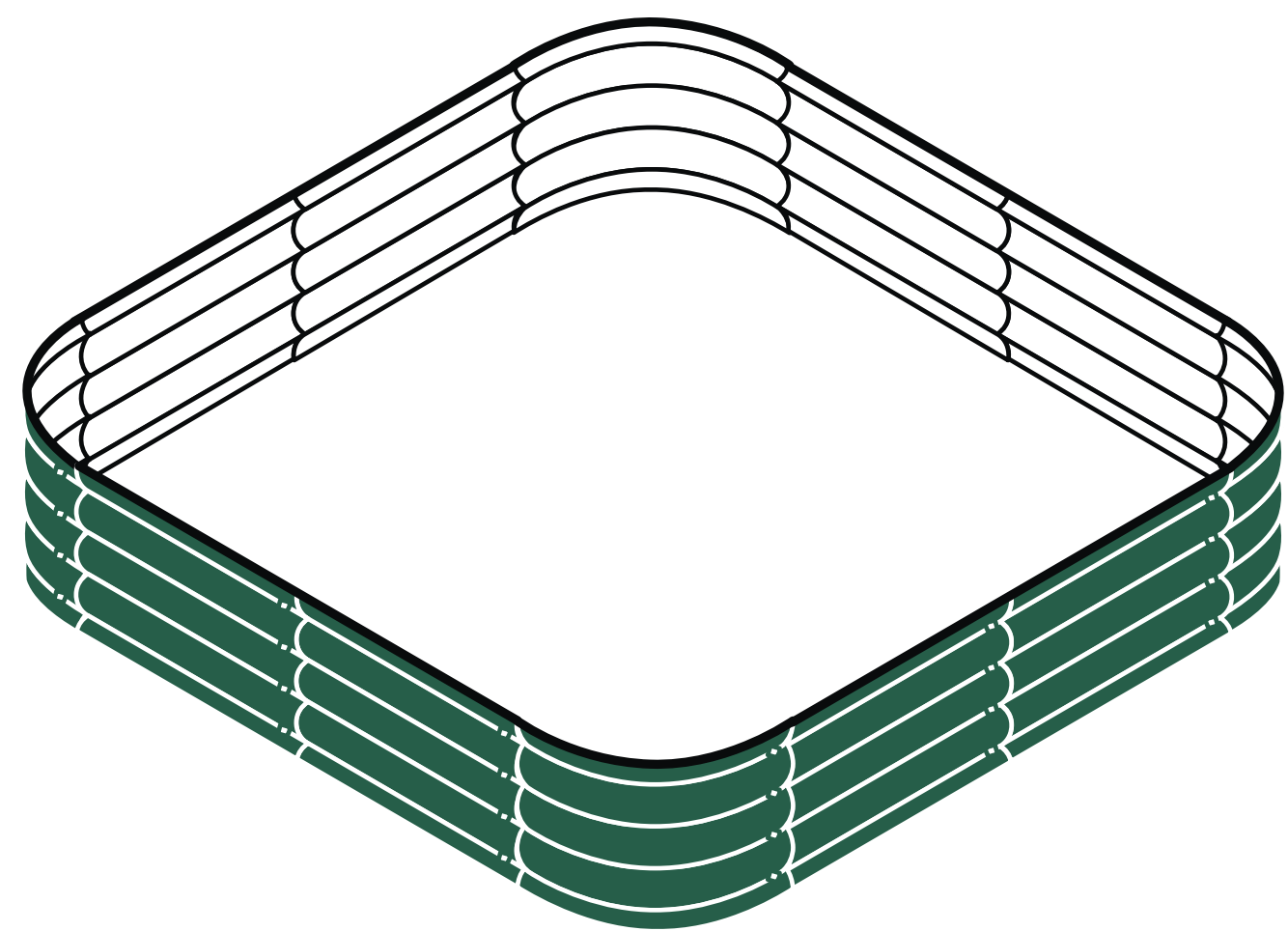
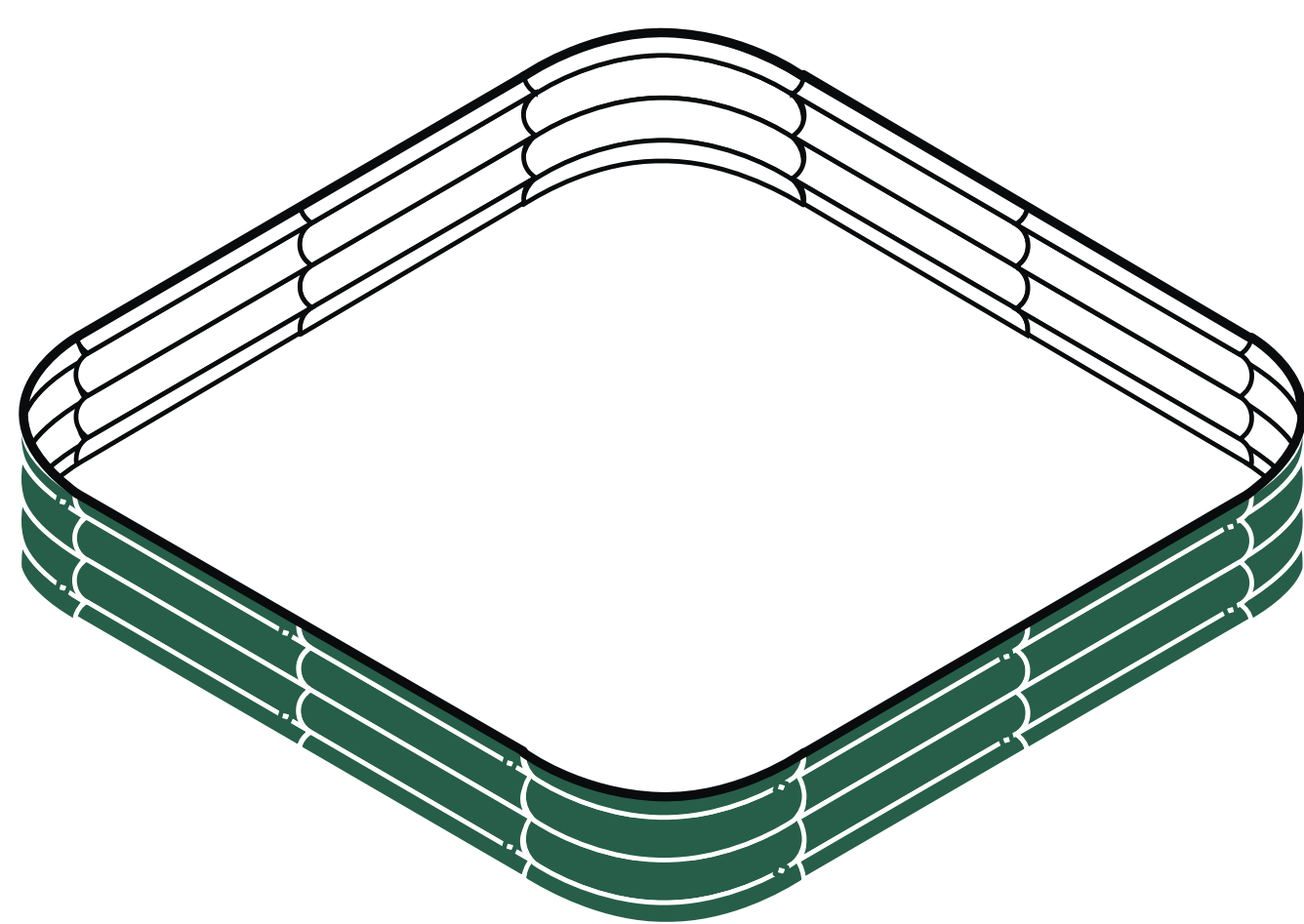
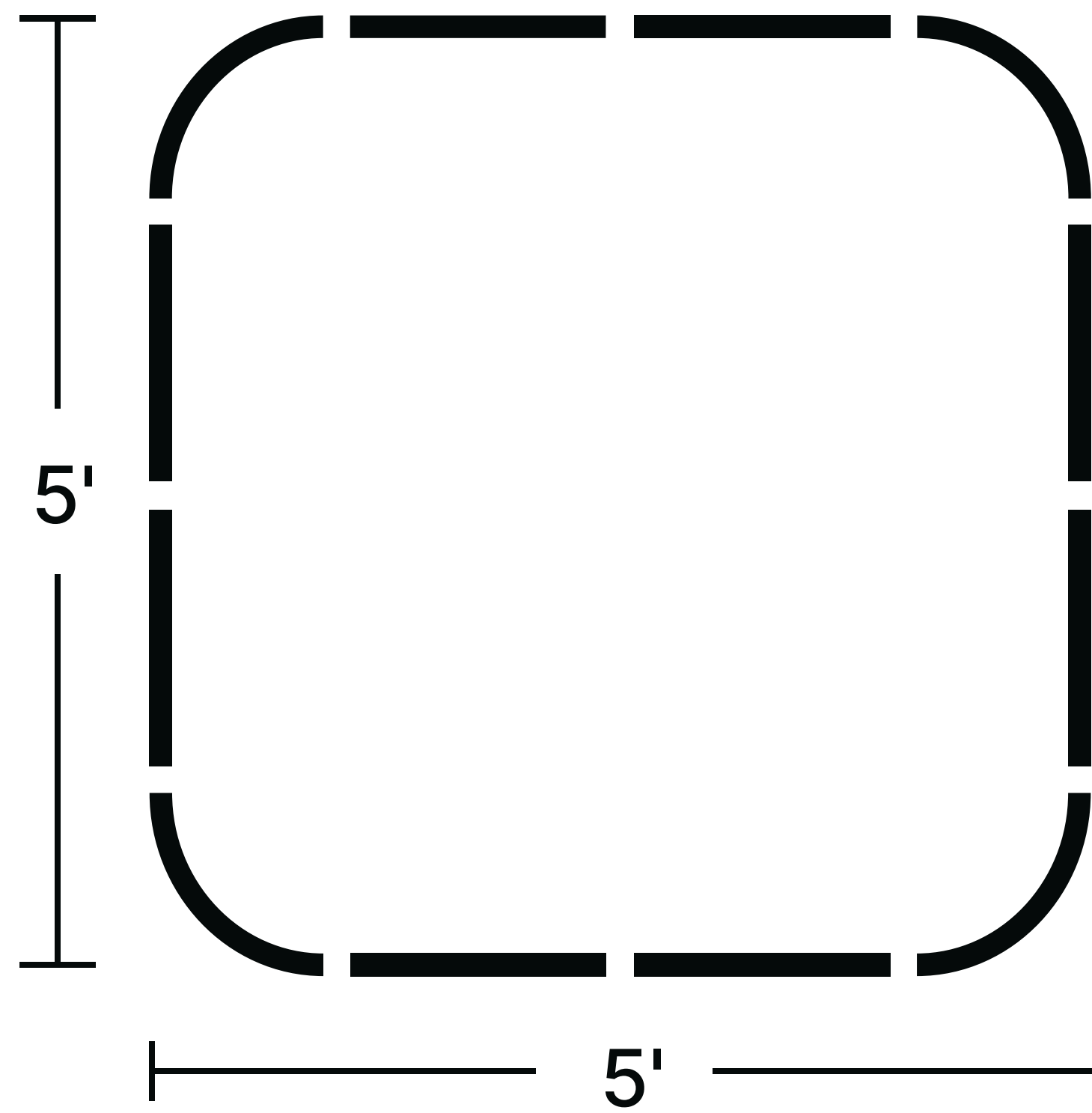

ASSEMBLY INSTRUCTION

6 in 1 Size: 6.5'x2'

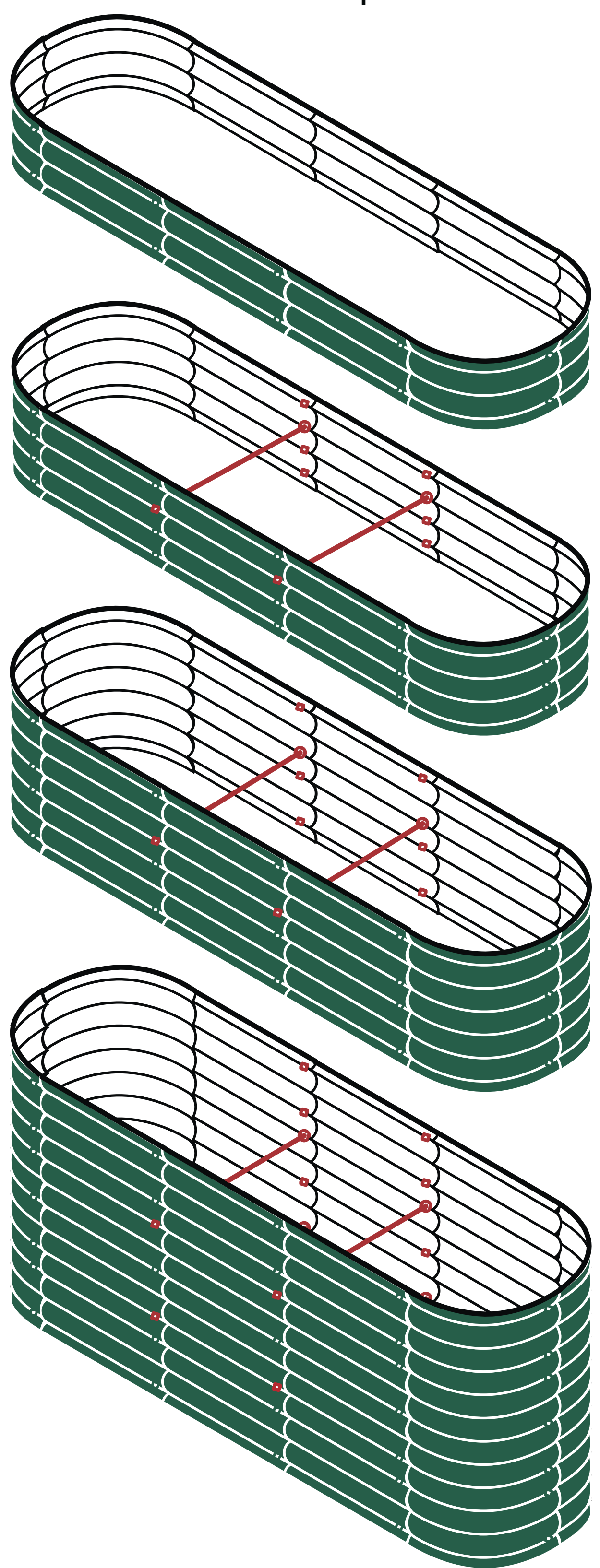

8"

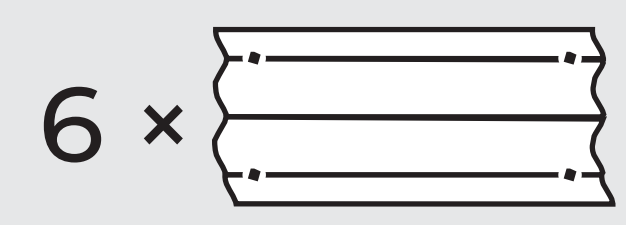
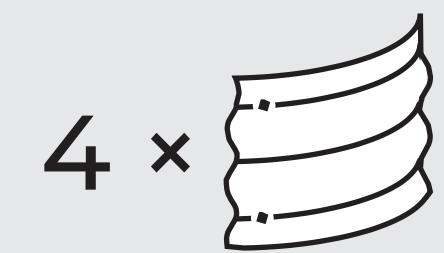

11"

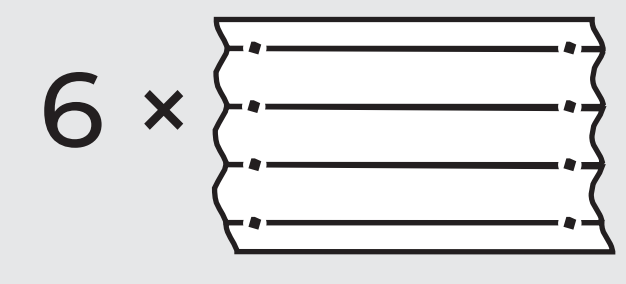
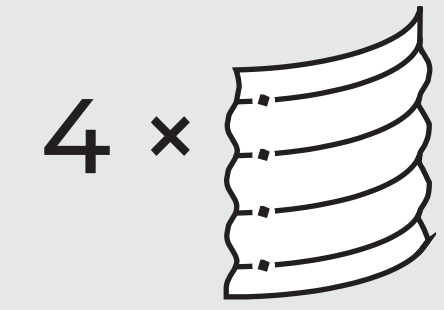

17"

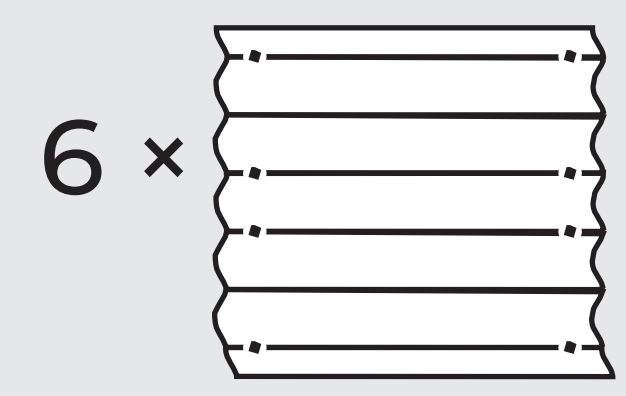
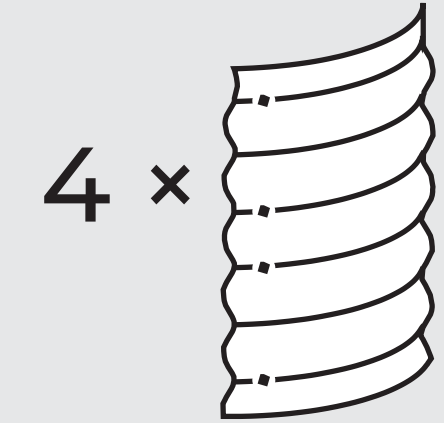

32"

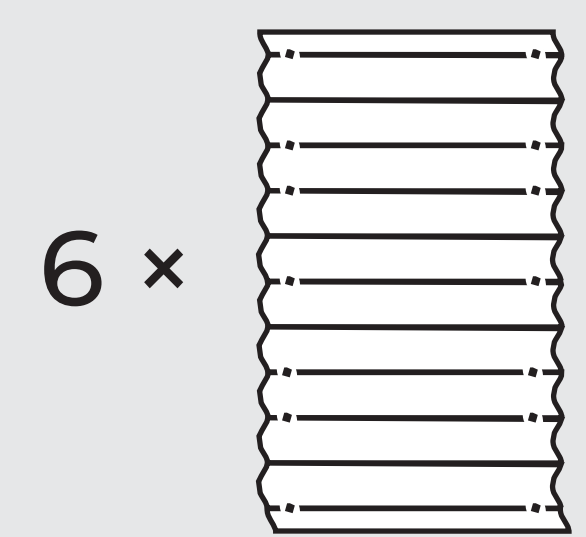
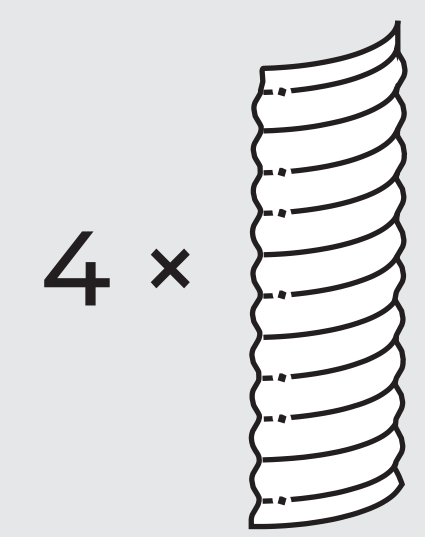

ASSEMBLY INSTRUCTION

6 in 1 Size: 5'x3.5'

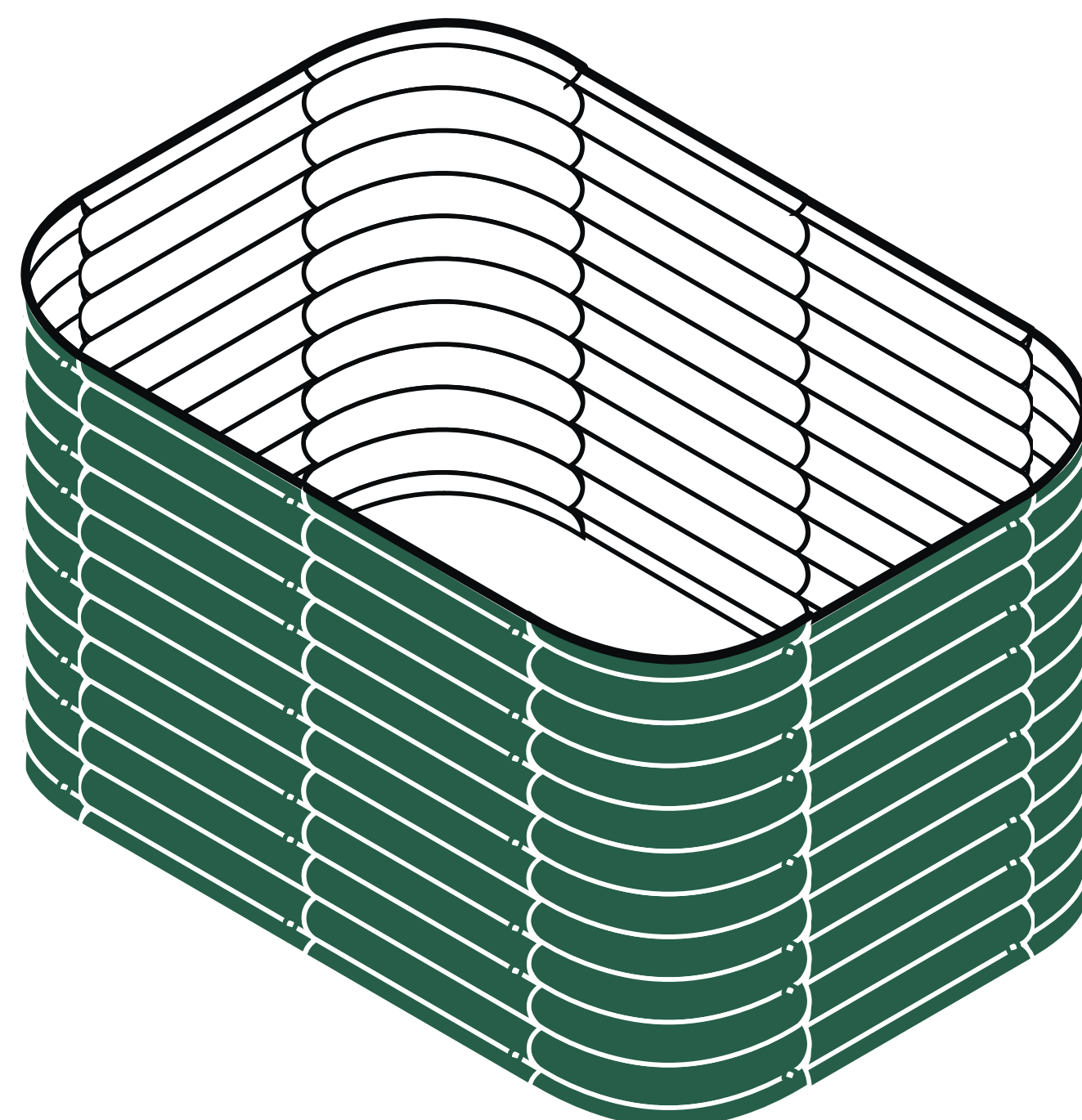
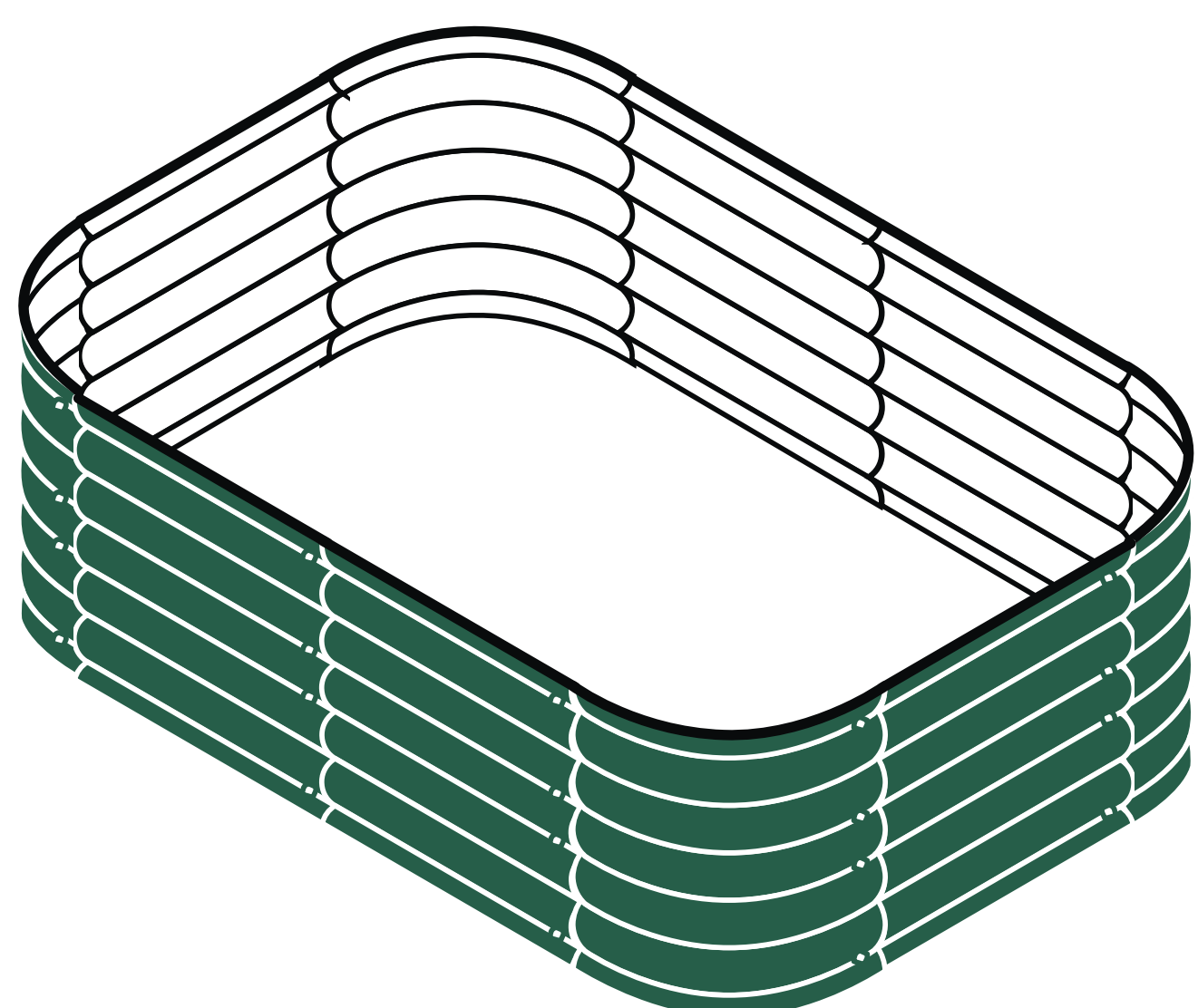
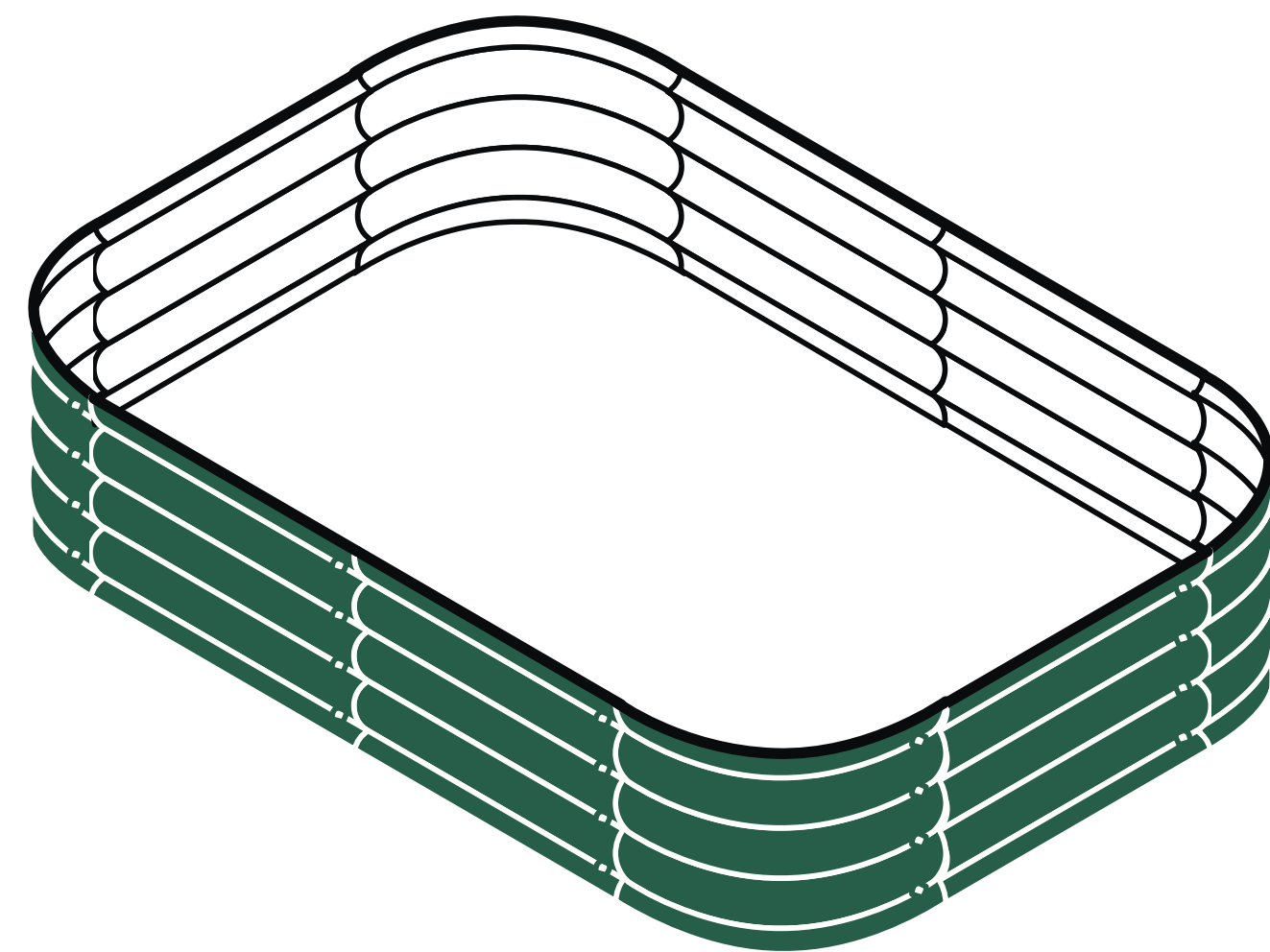
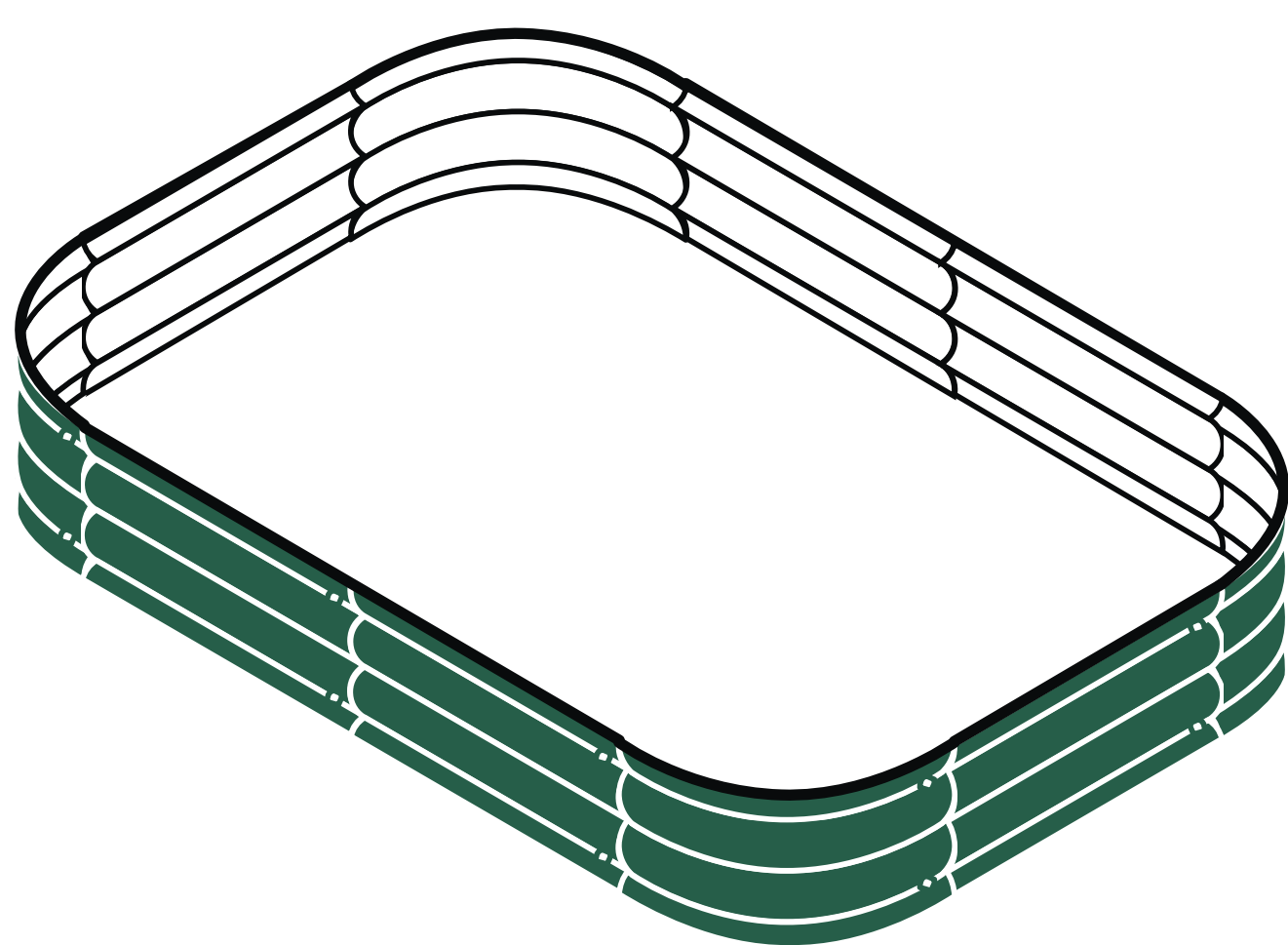
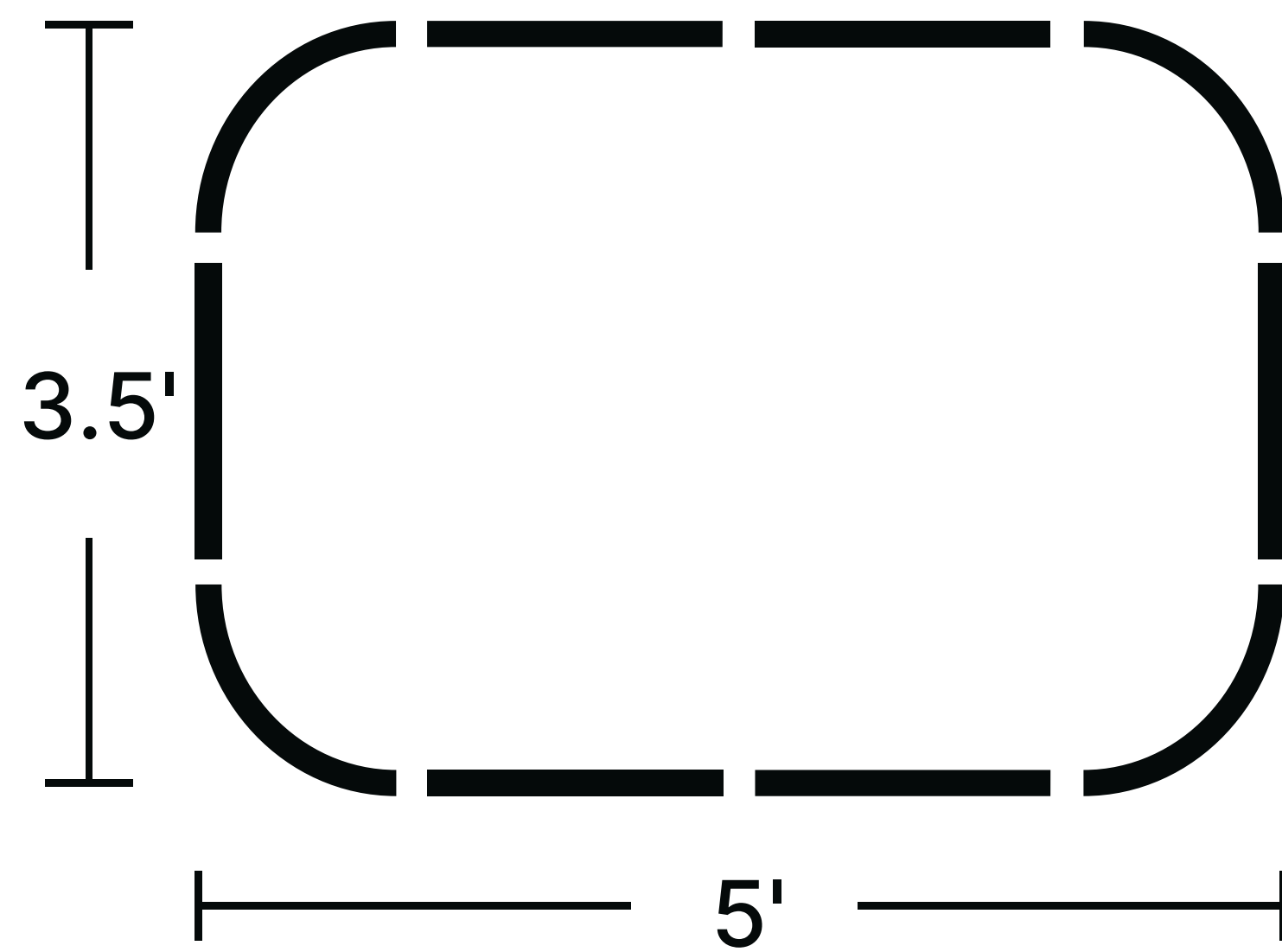

ASSEMBLY INSTRUCTION

4 in 1 Size: 5'x2'

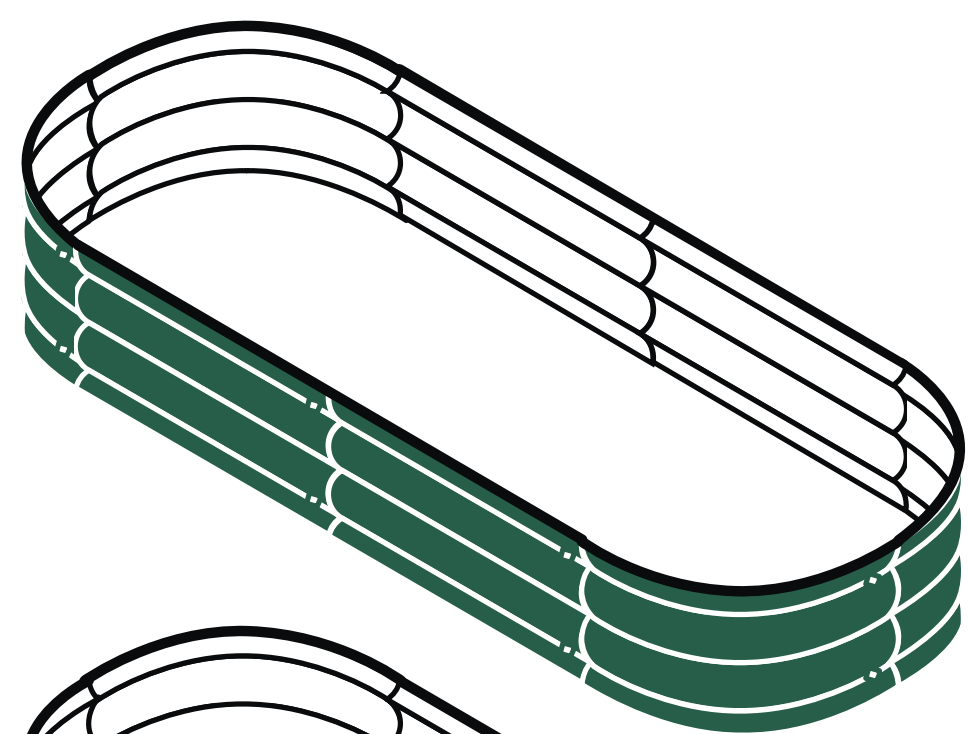
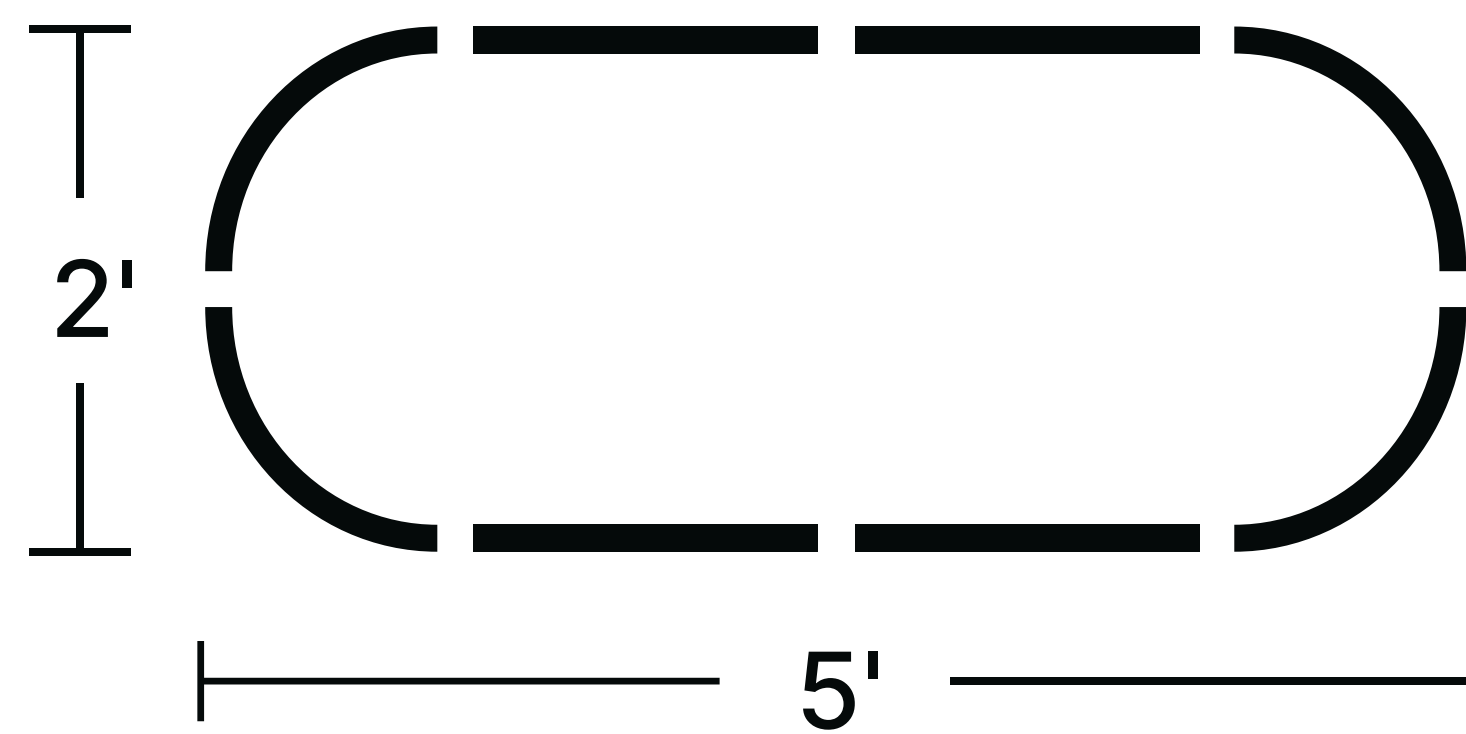

8"

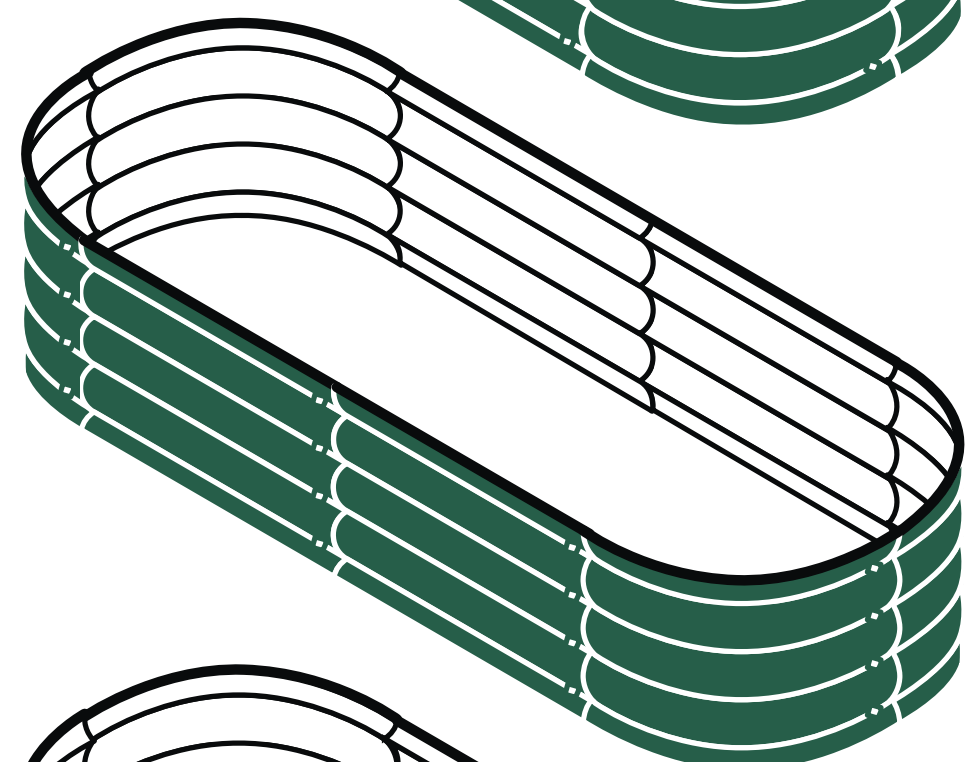
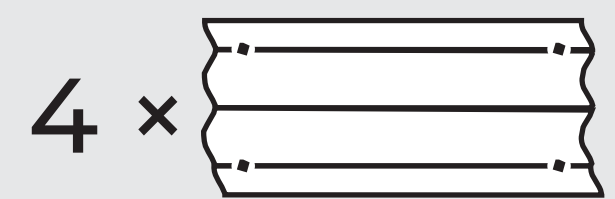
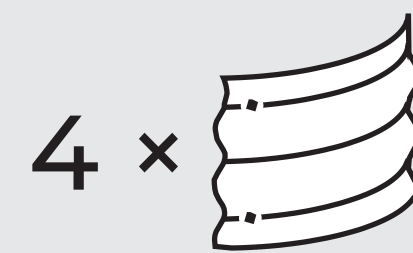

11"

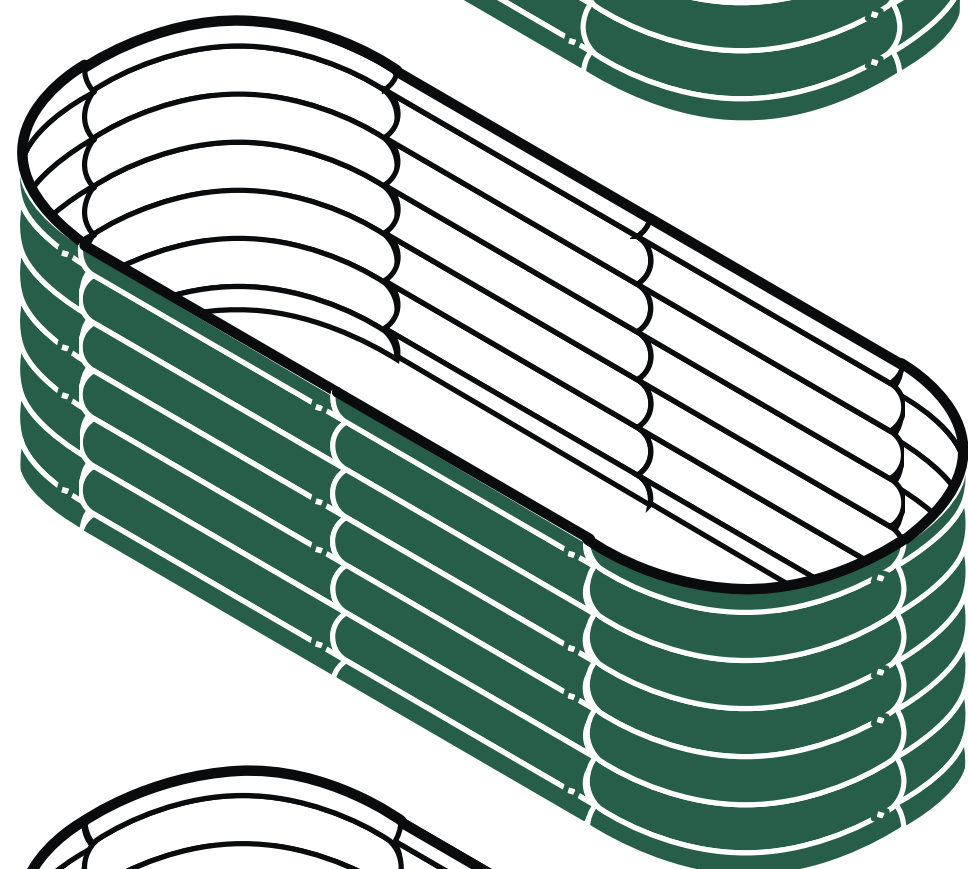
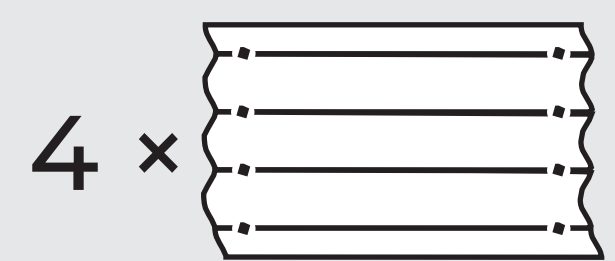

17"

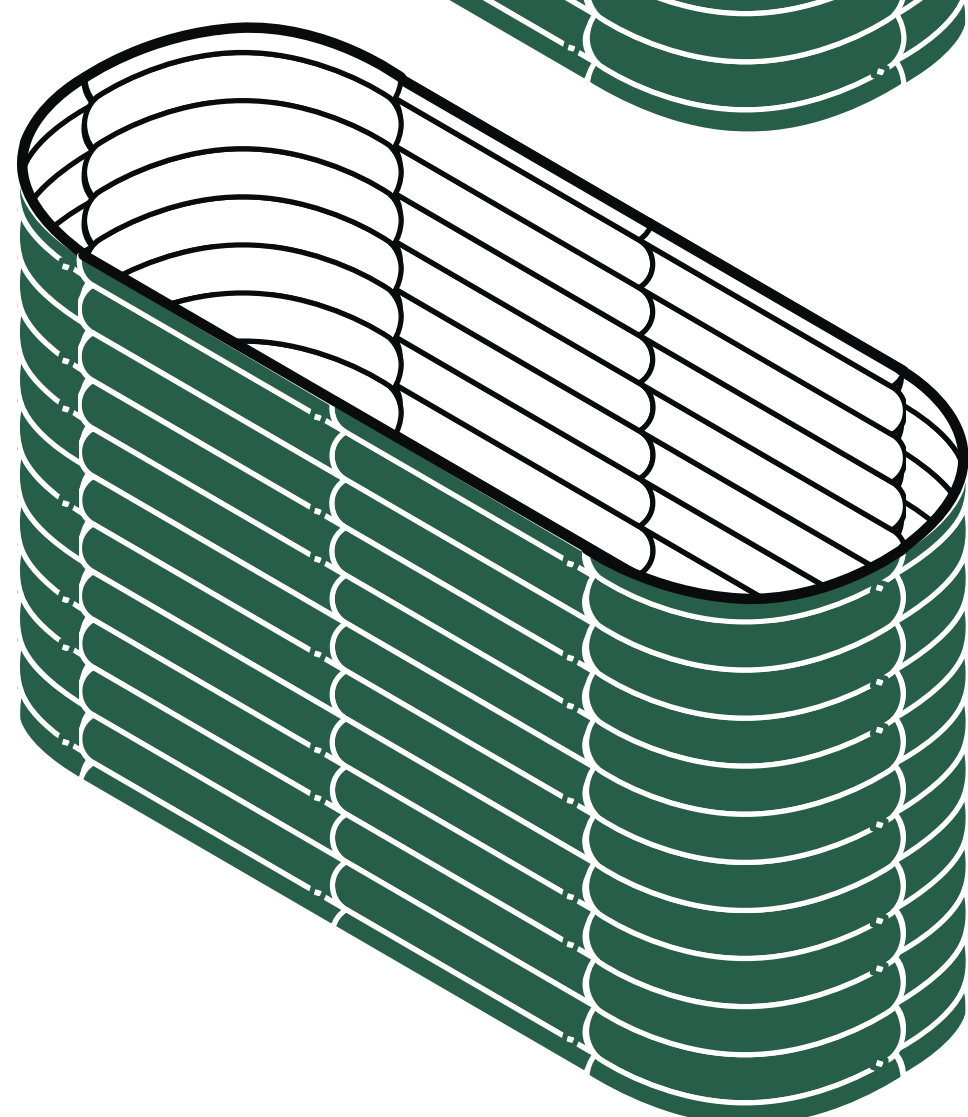
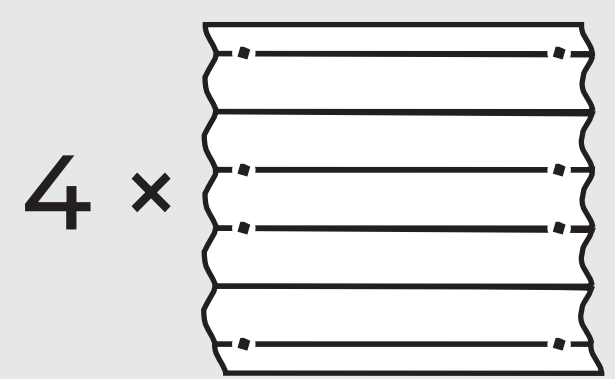
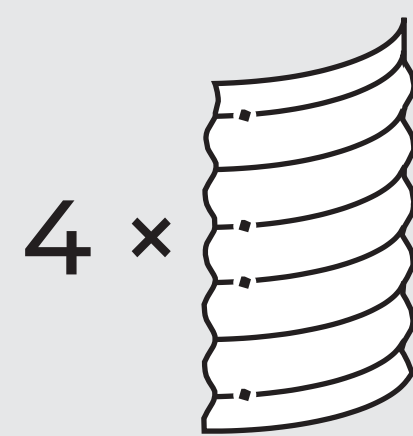

32"

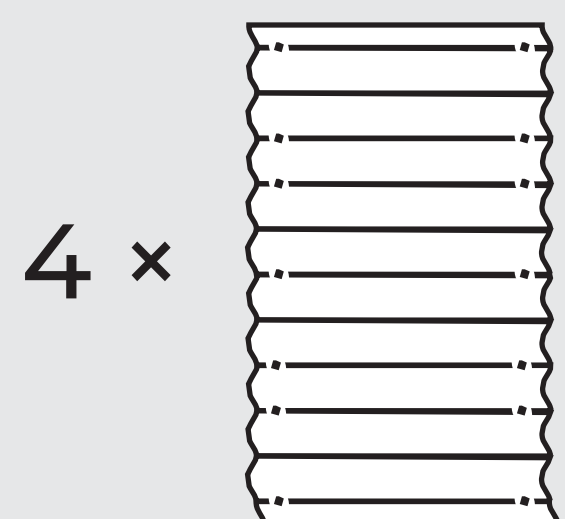

ASSEMBLY INSTRUCTION

4 in 1 *Size: 3.5'x3.5'*

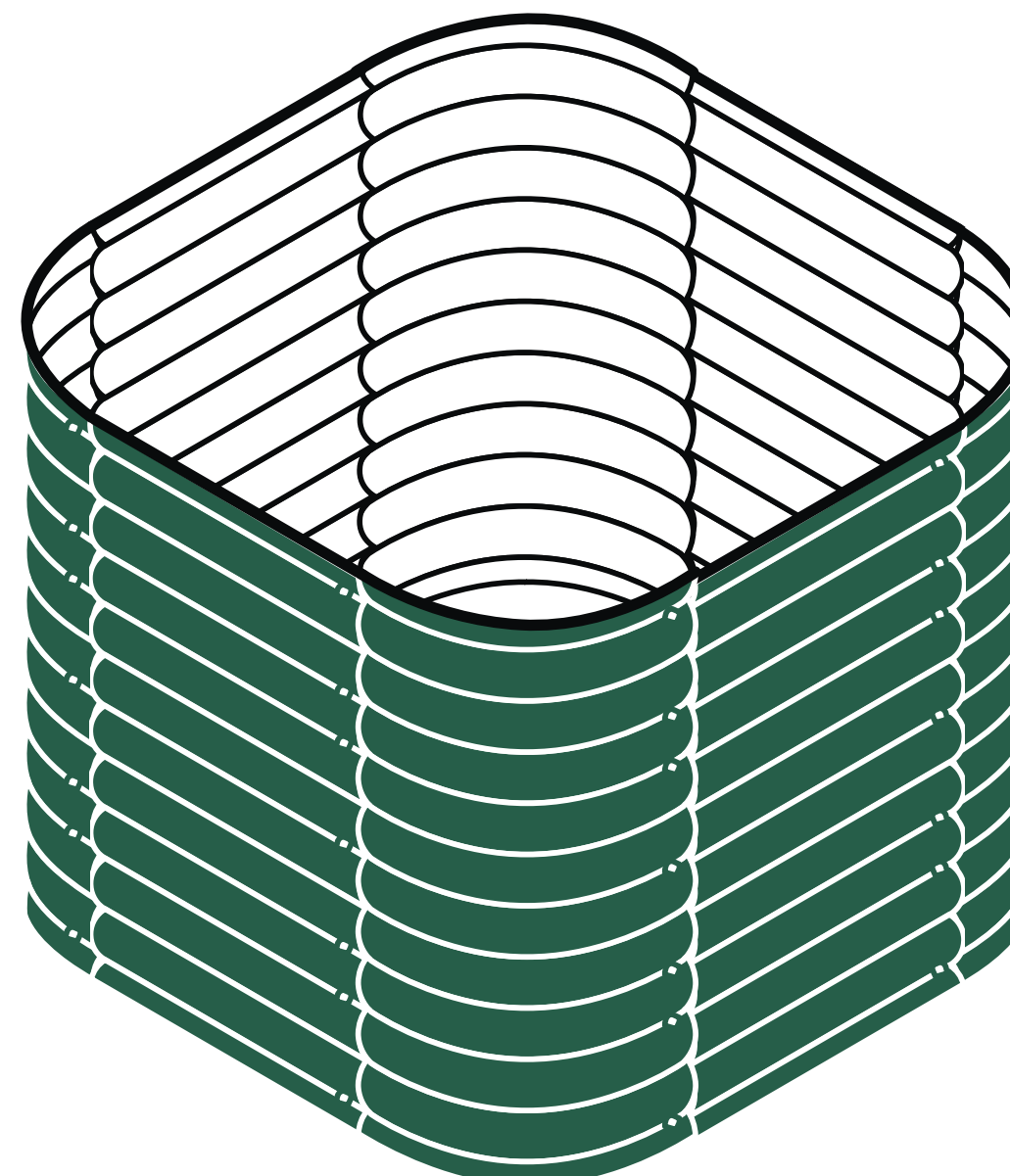
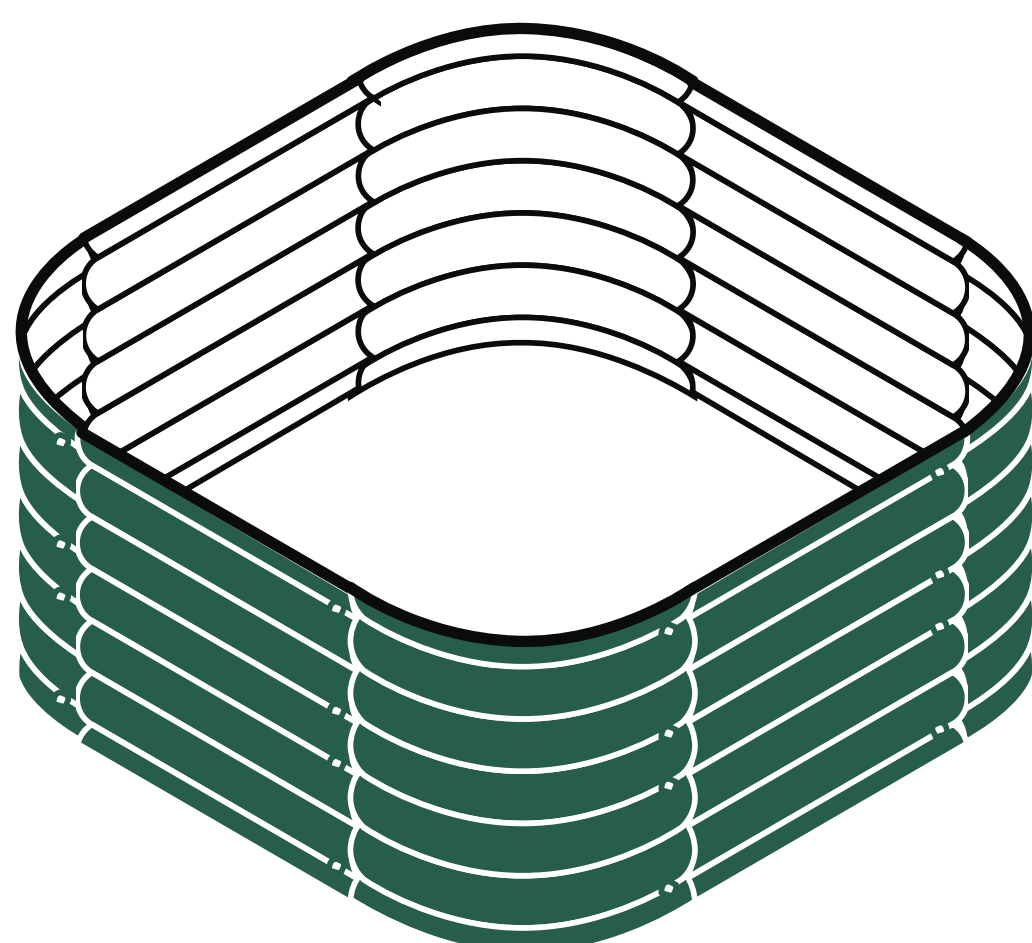
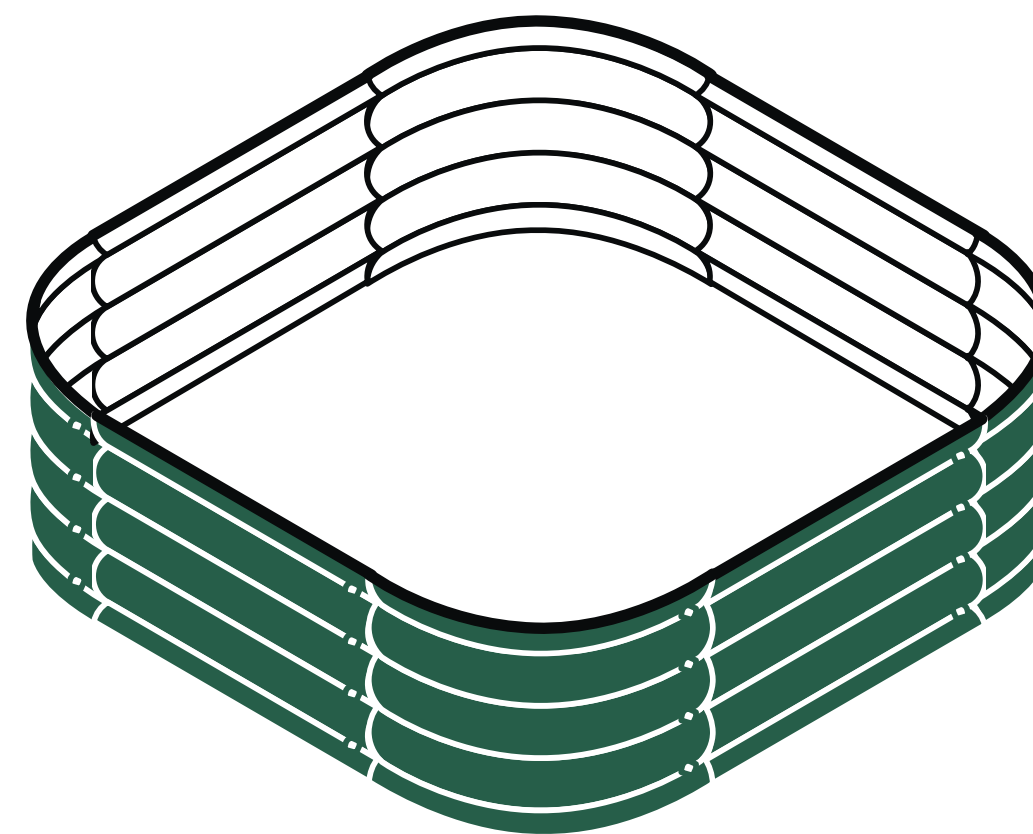
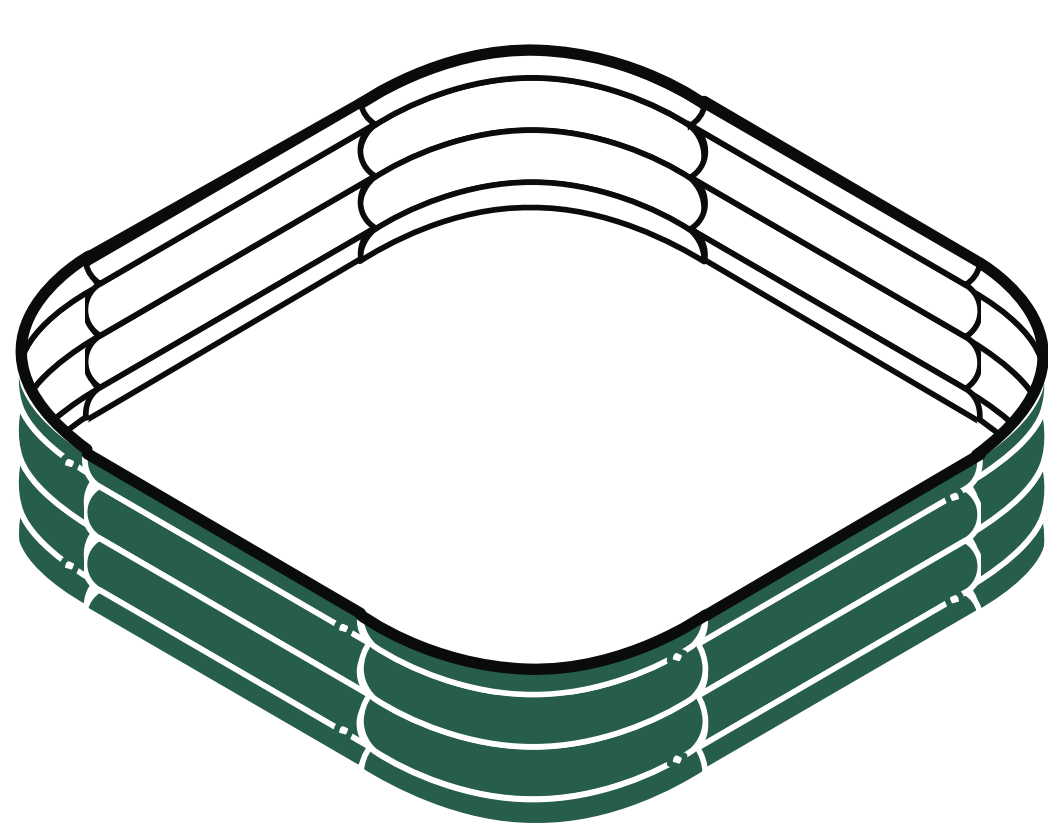
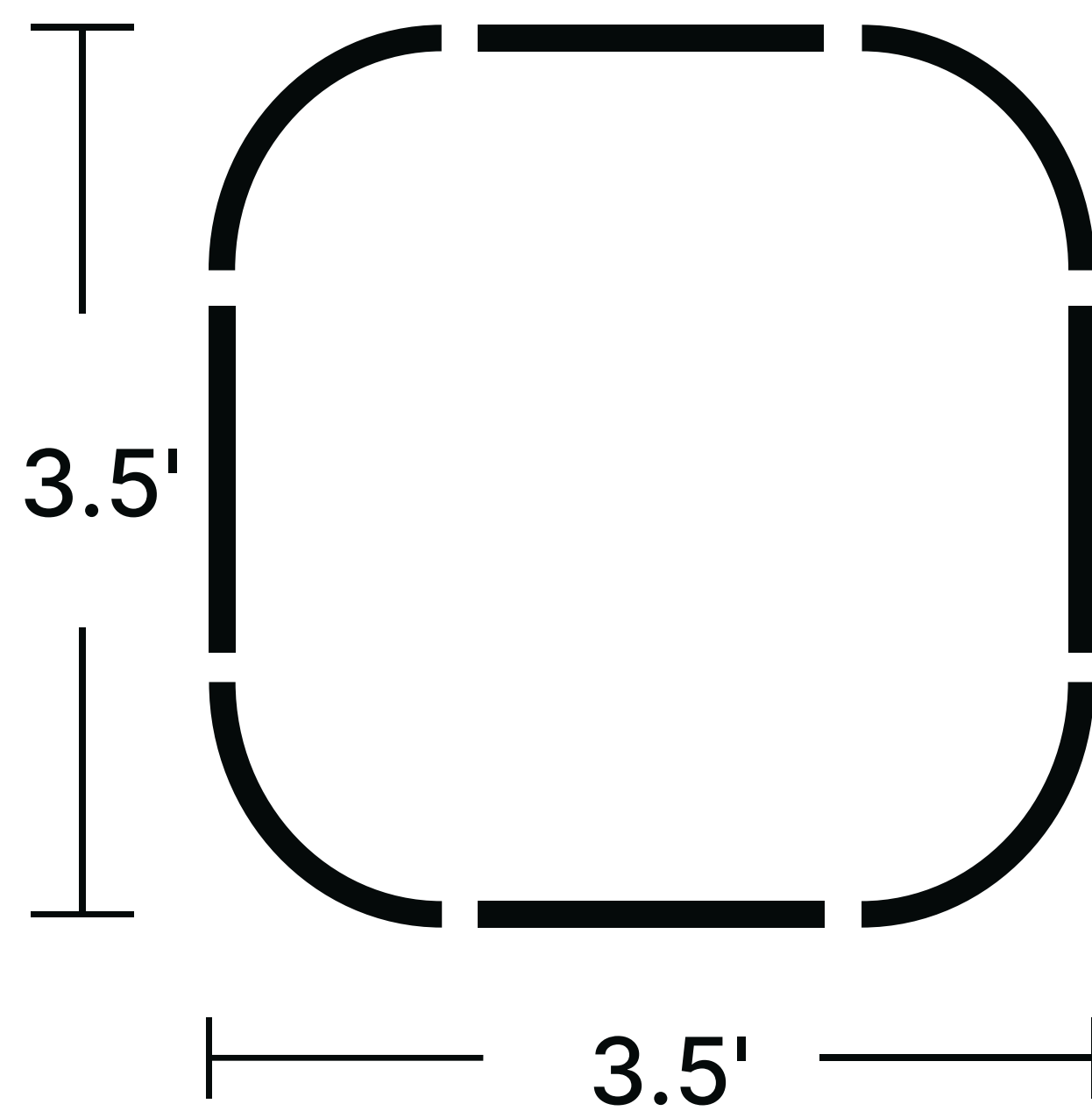

ASSEMBLY INSTRUCTION

2 in 1 Size: 3.5'x2'

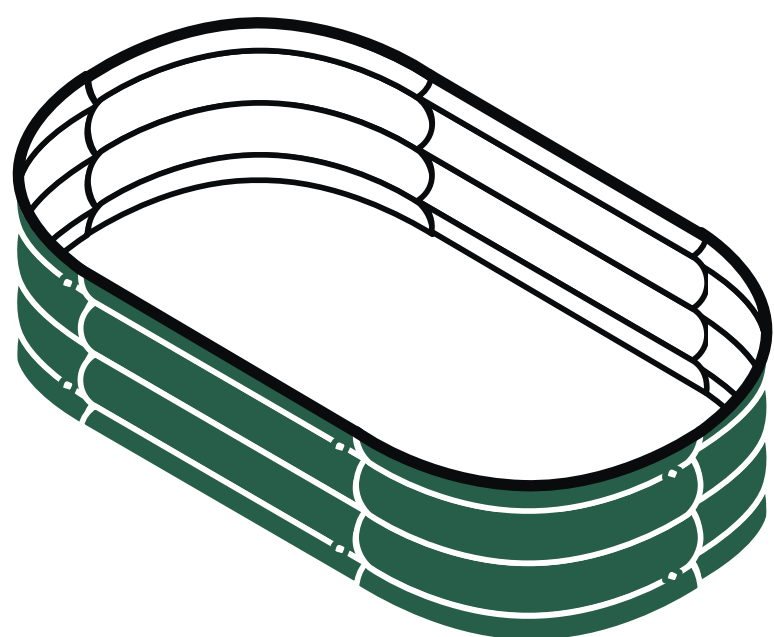
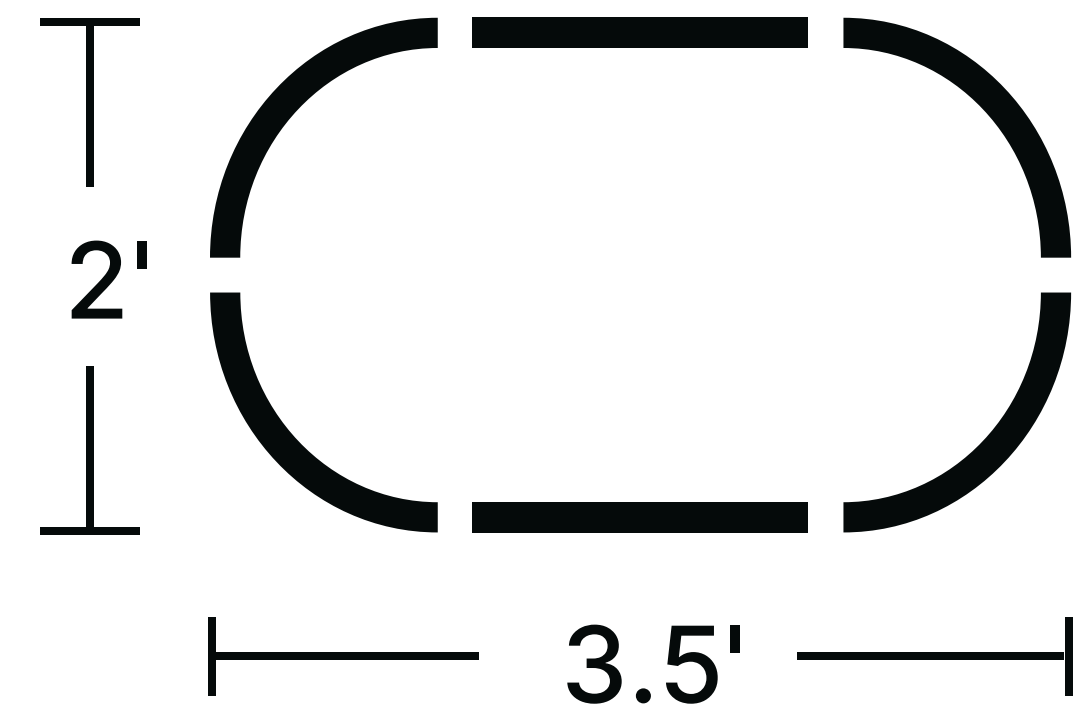

8"

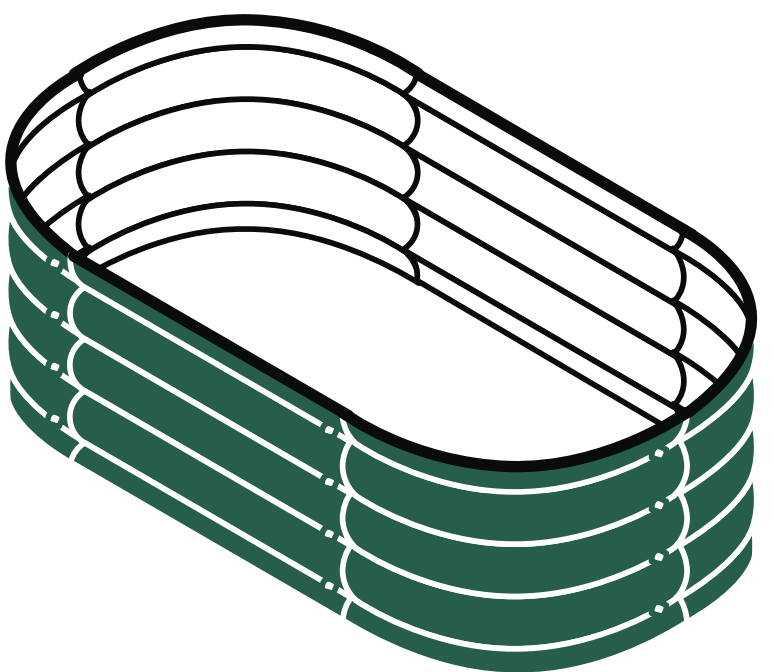
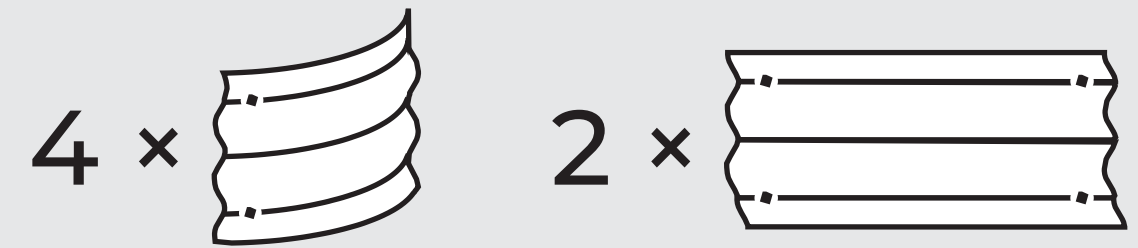

11"

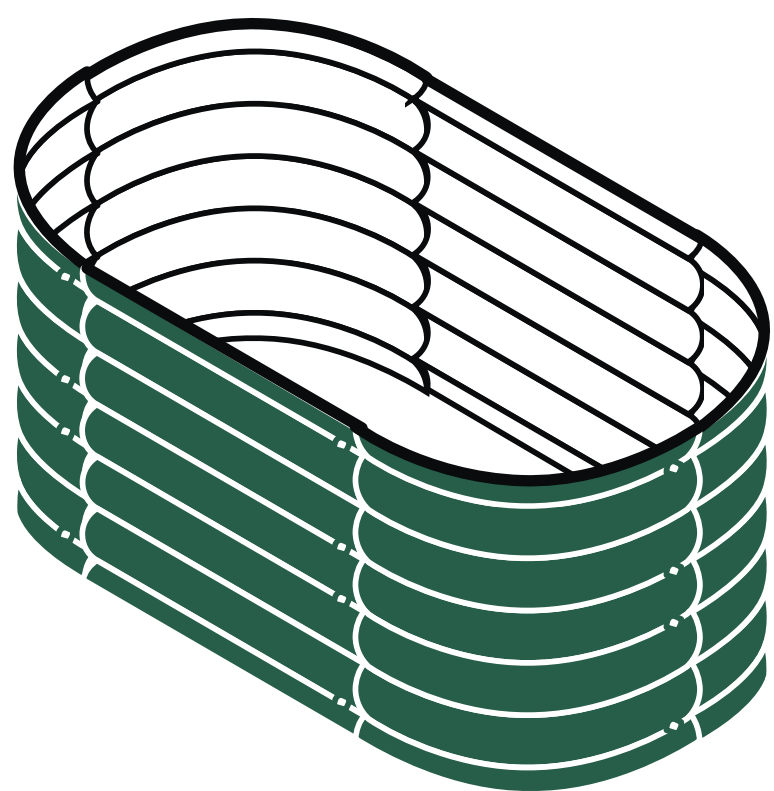
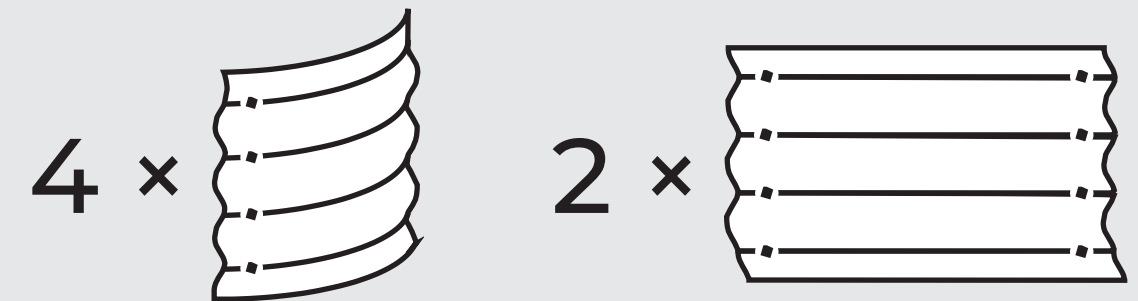

17"

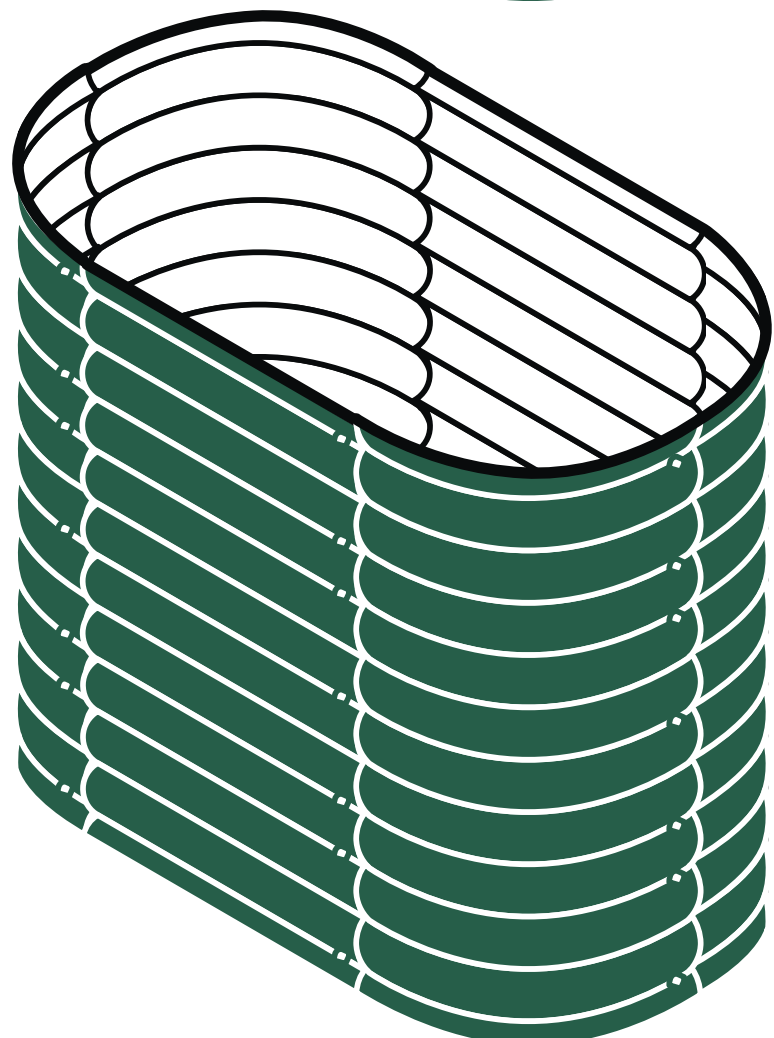
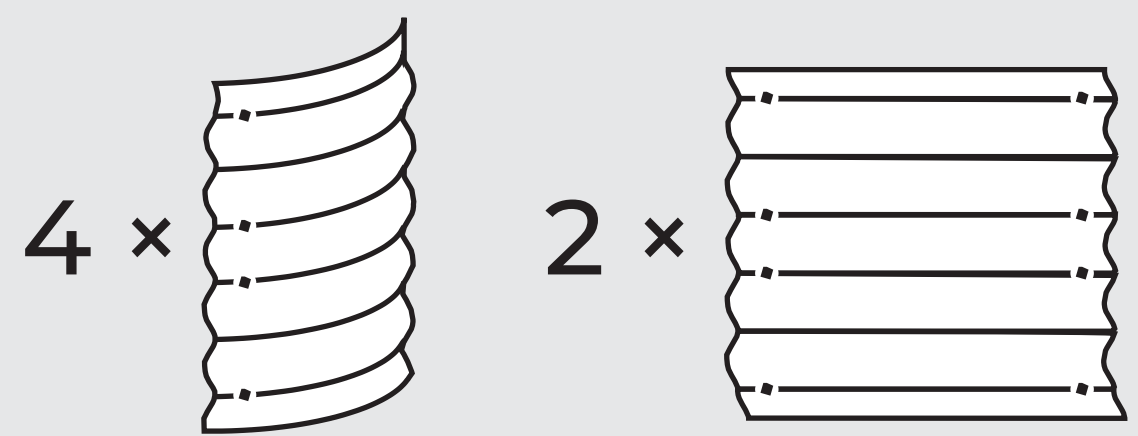

32"

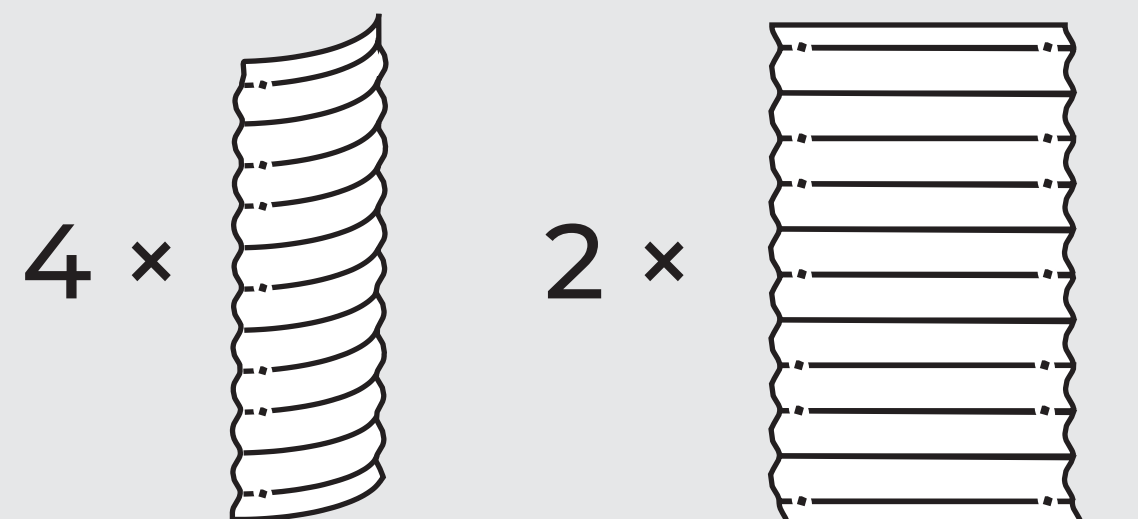

ASSEMBLY INSTRUCTION

24'' Round

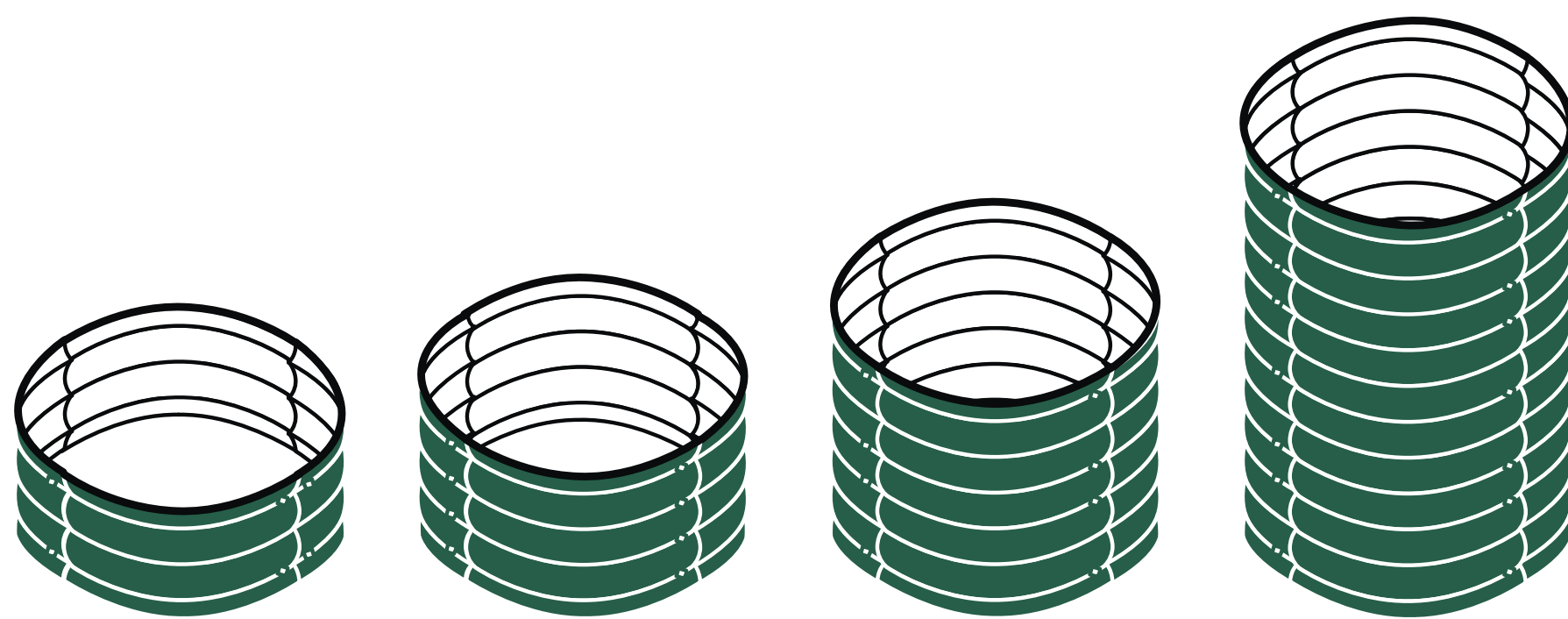
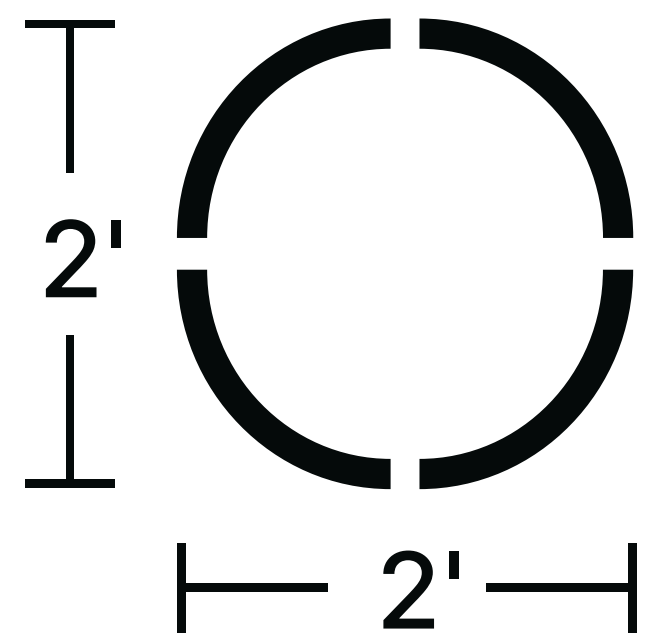

8''

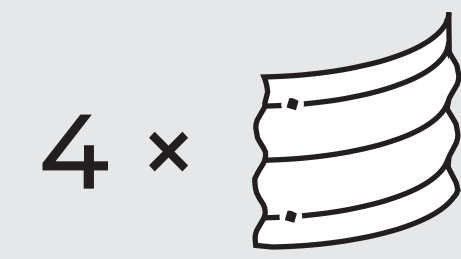

11''

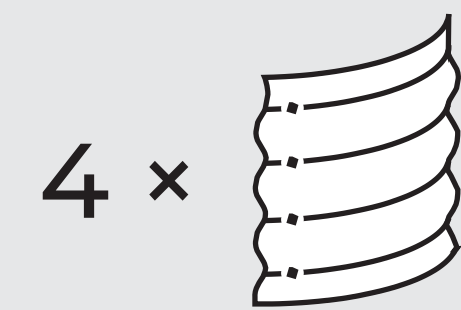

17''



32''

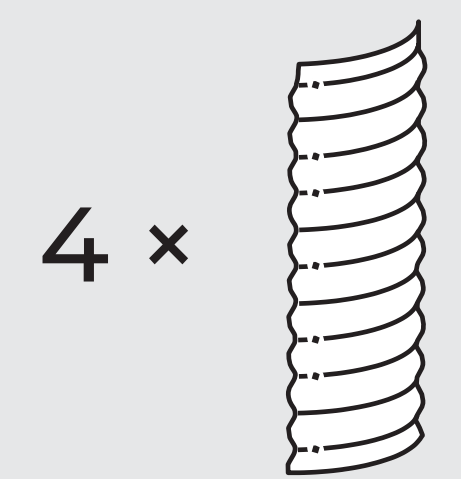

42'' Round

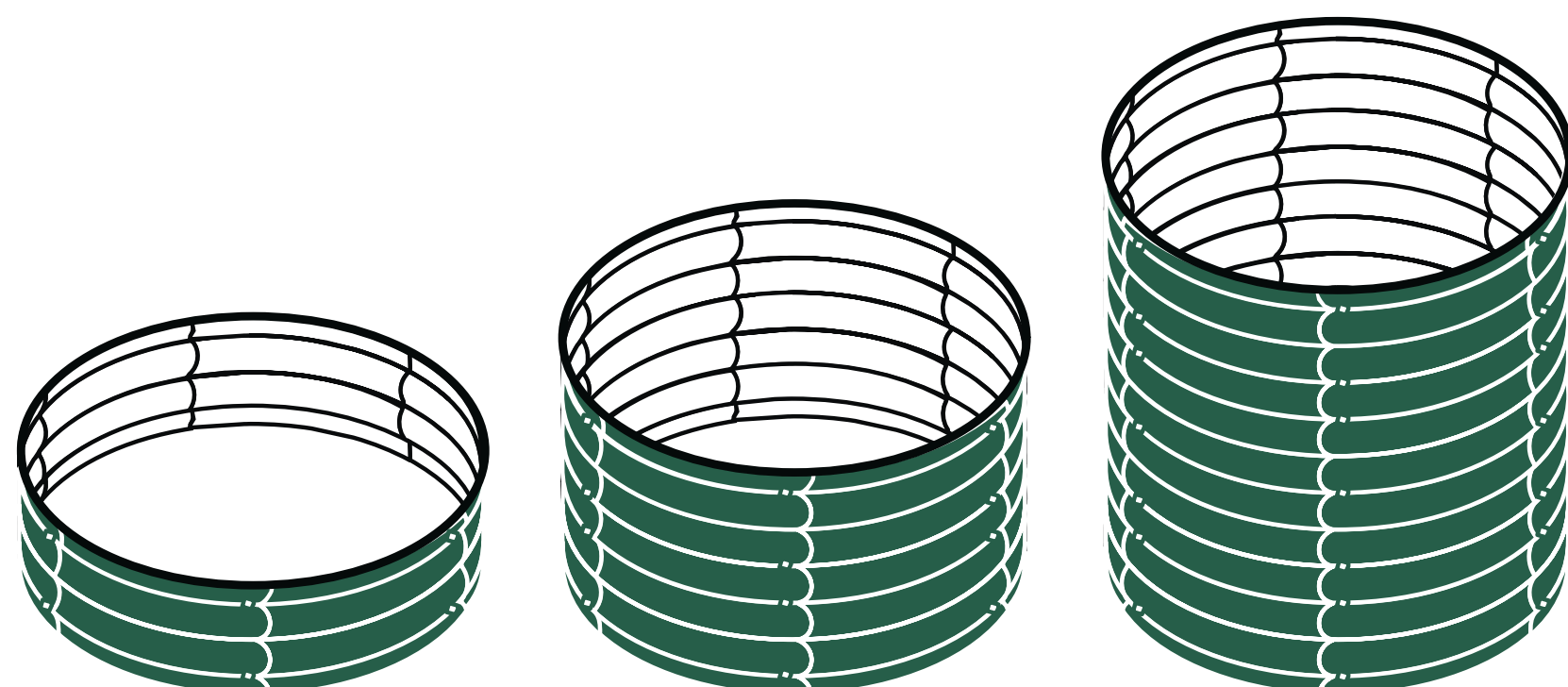
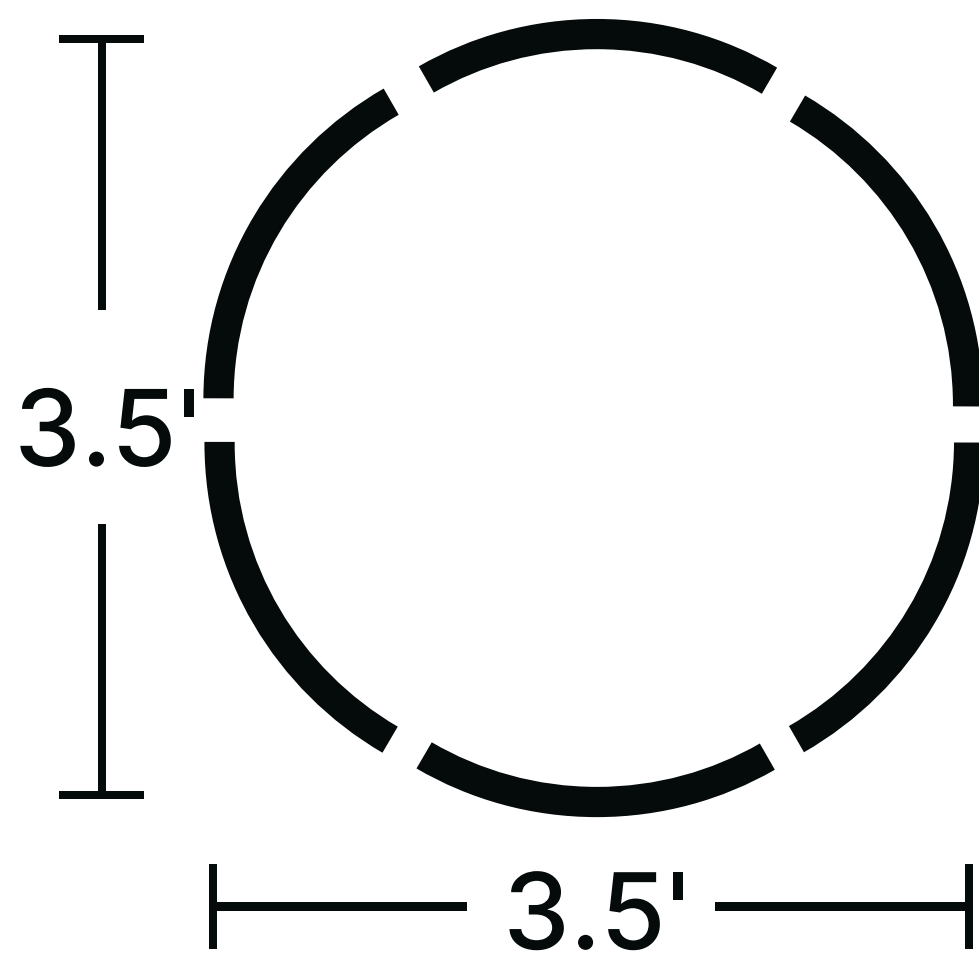

8''



17''



32''

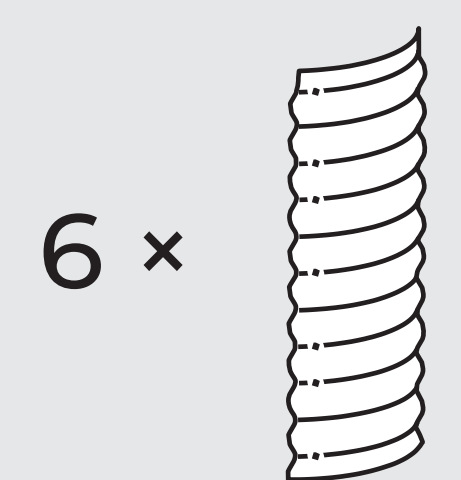

ASSEMBLY INSTRUCTION

SPECIAL SHAPES

Rectangle

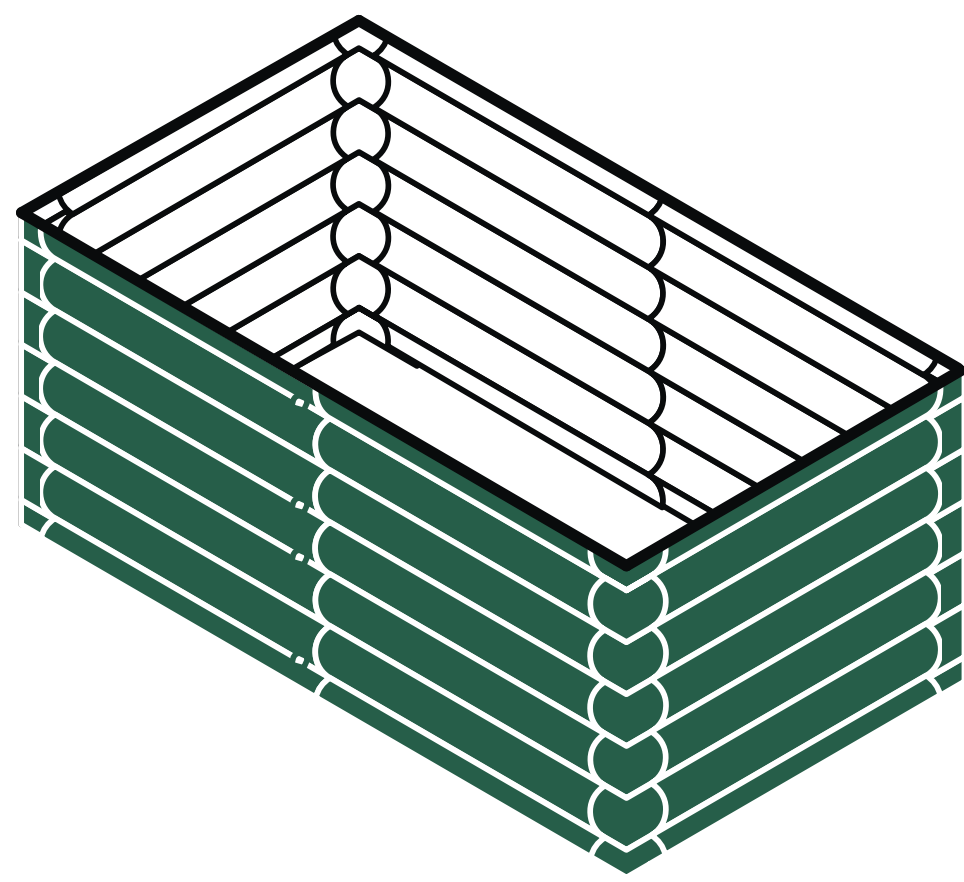
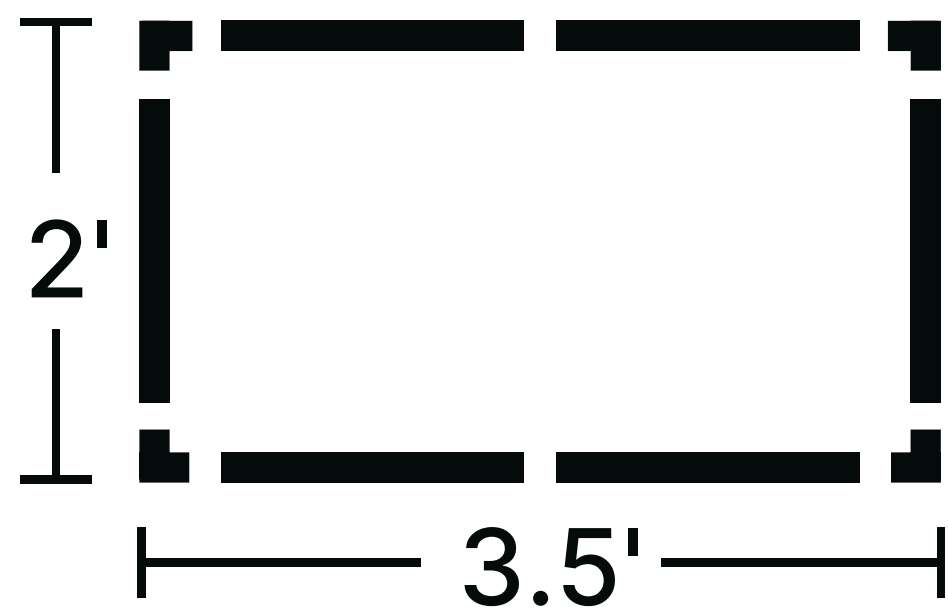

4 x



6 x

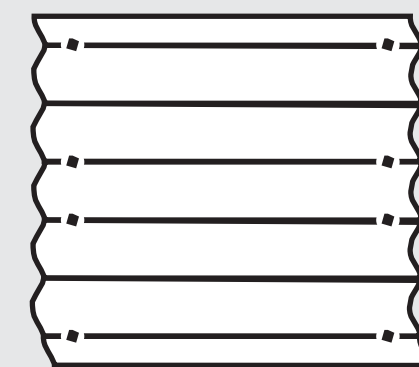

Square

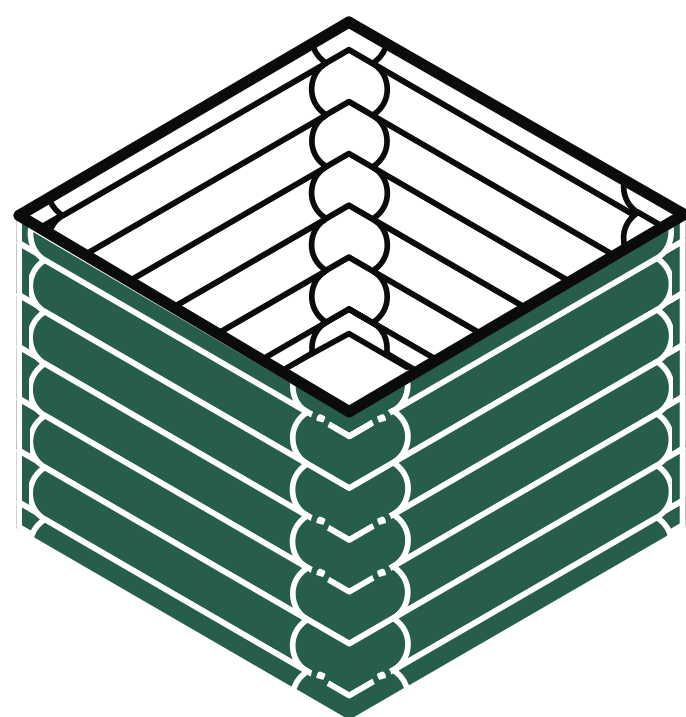
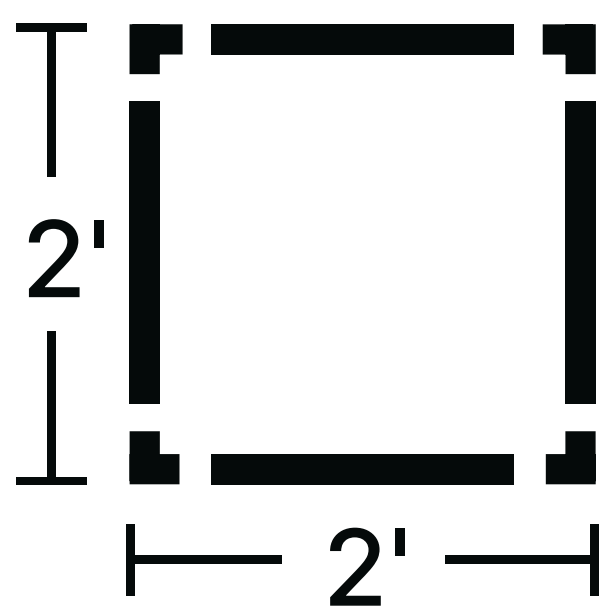

4 x



4 x

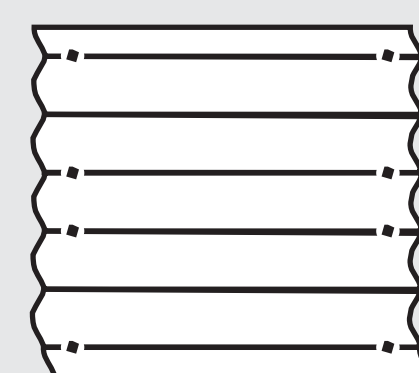

ASSEMBLY INSTRUCTION

SPECIAL SHAPES

17" Tall 9 in 1 Rectangle

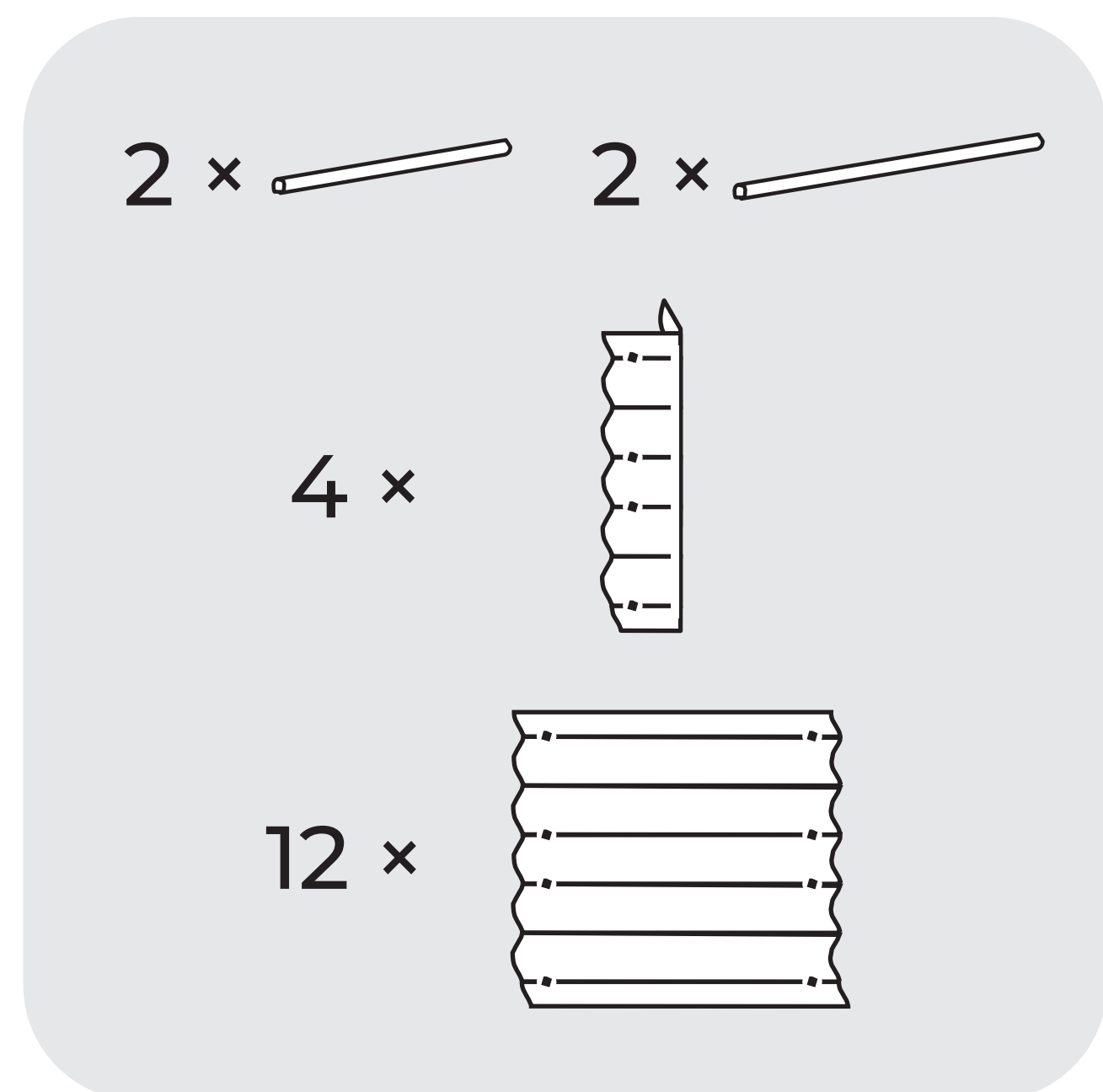
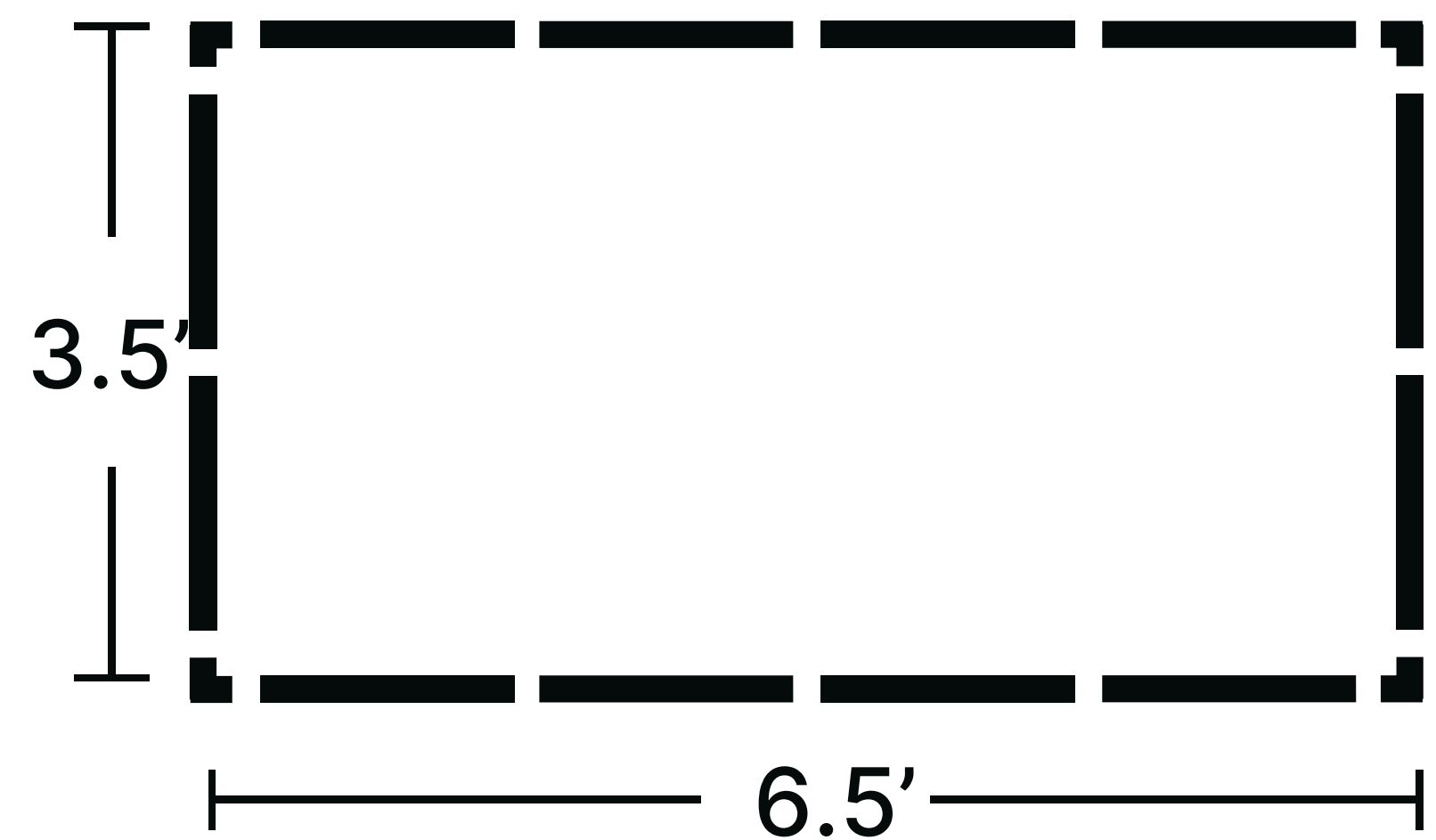
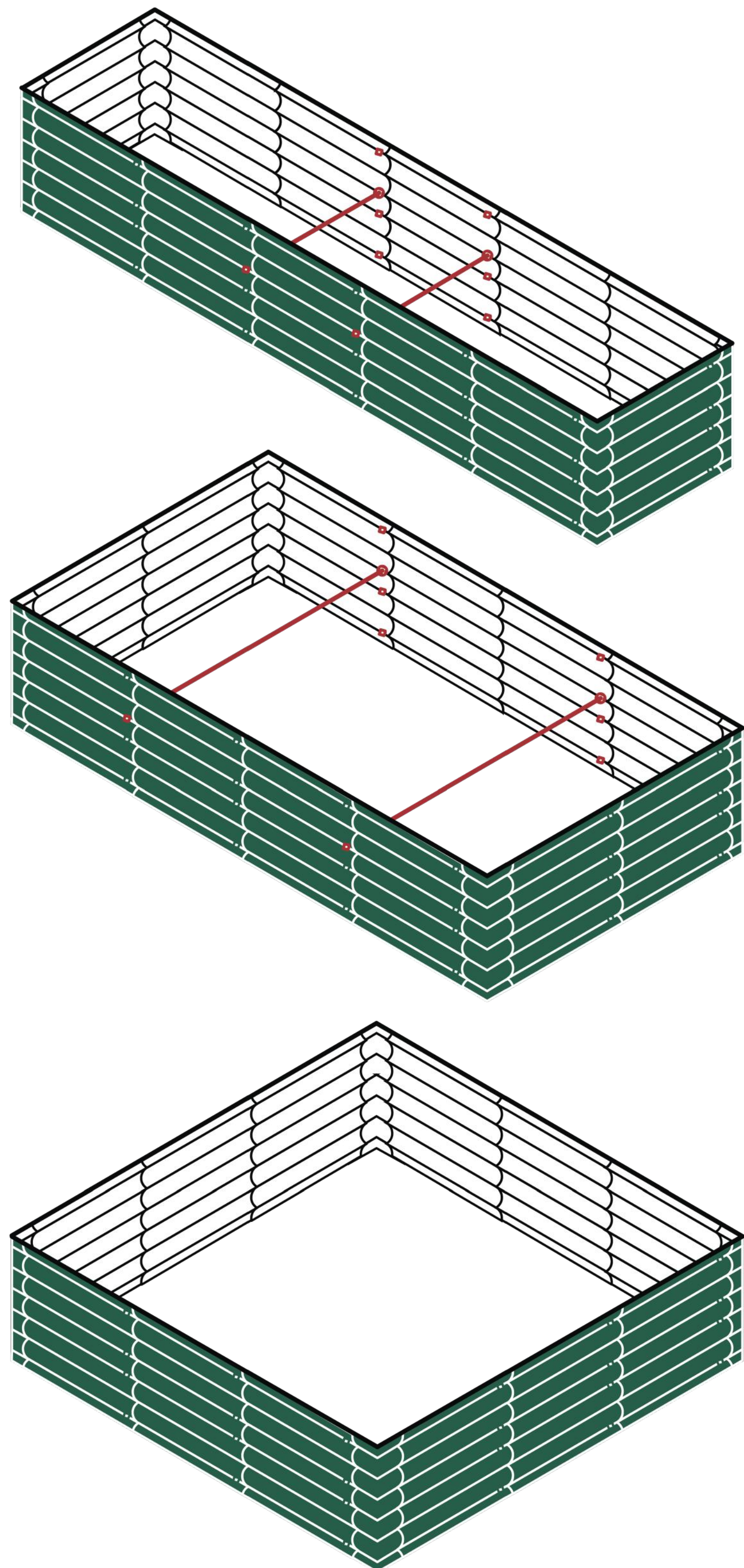
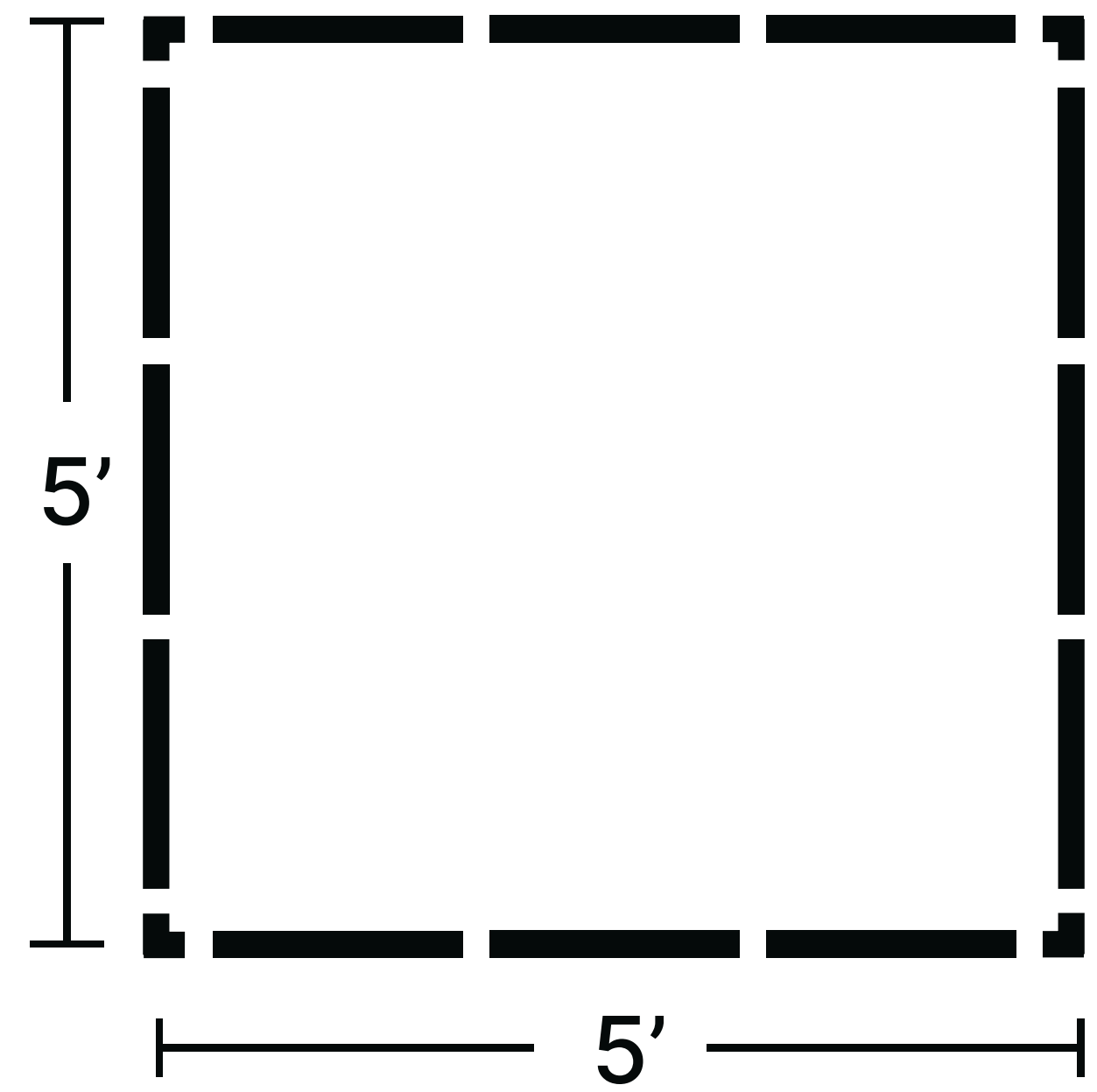
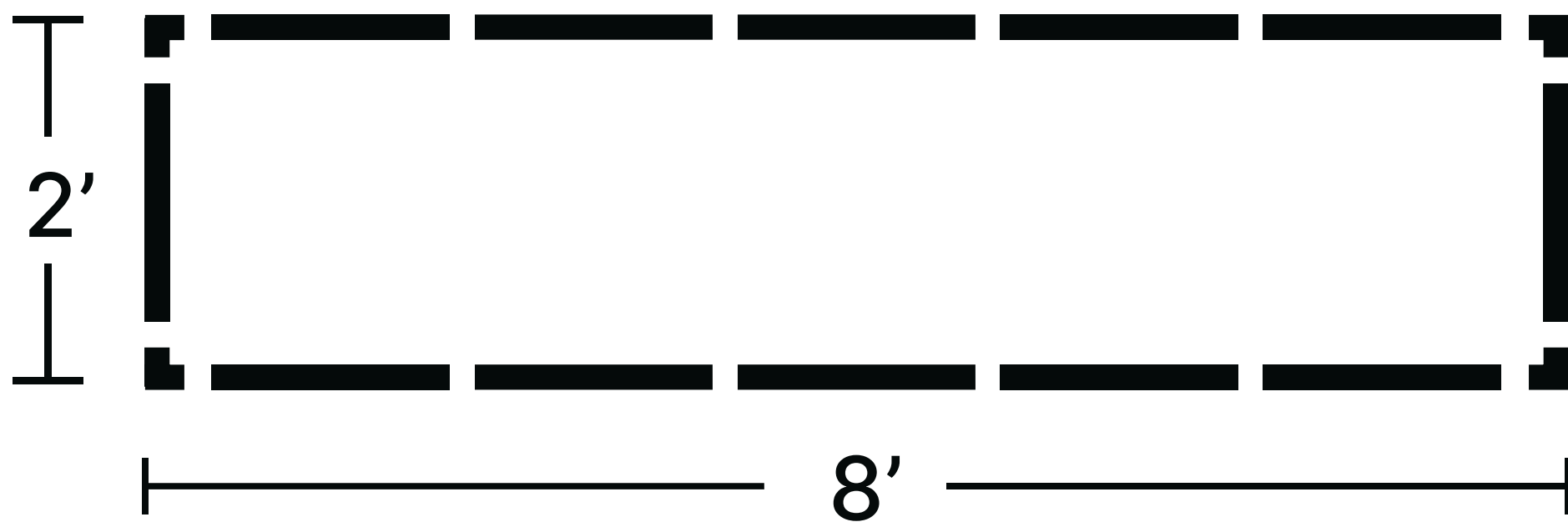



ASSEMBLY INSTRUCTION

SPECIAL SHAPES

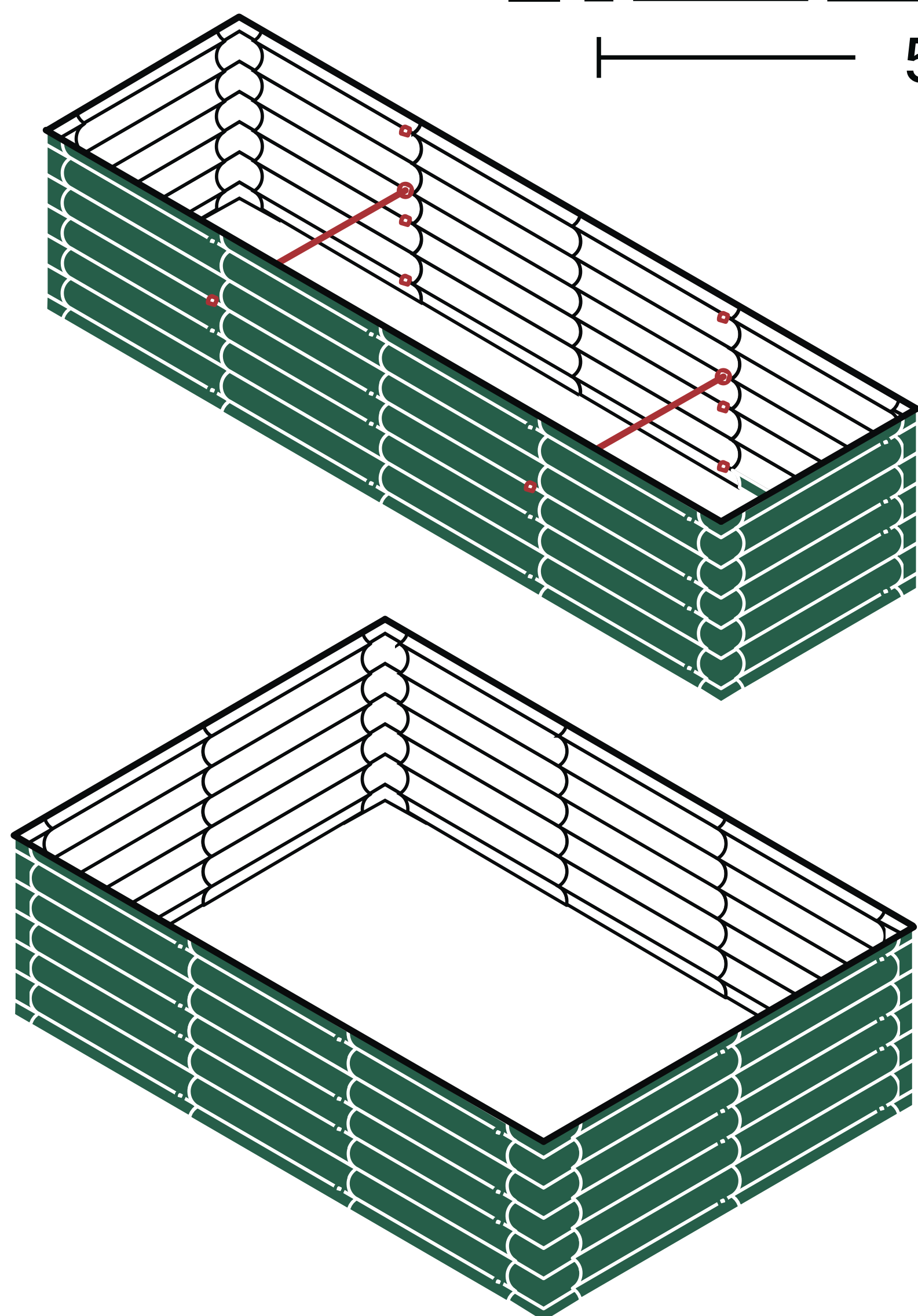
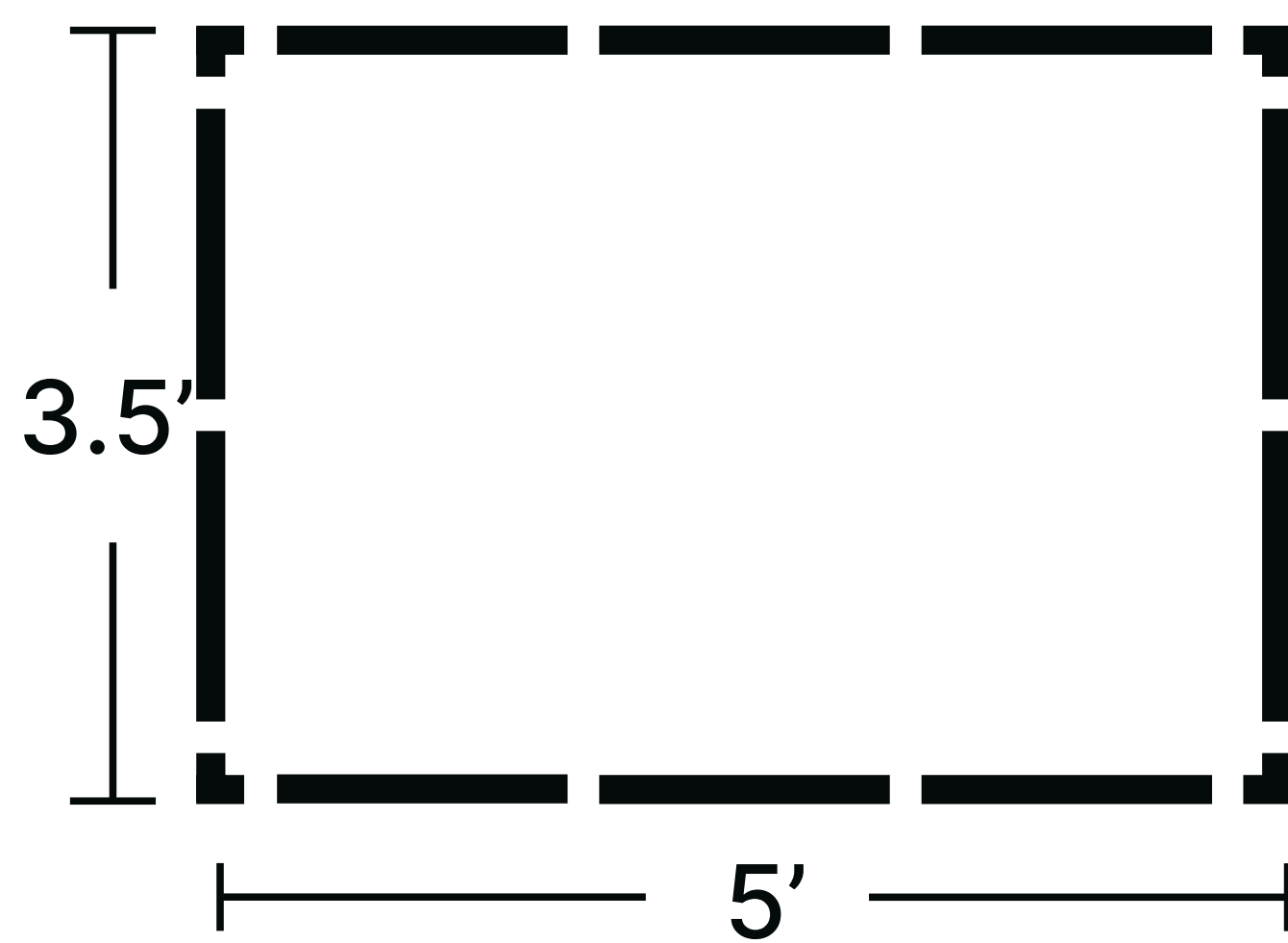
17" Tall 6 in 1 Rectangle

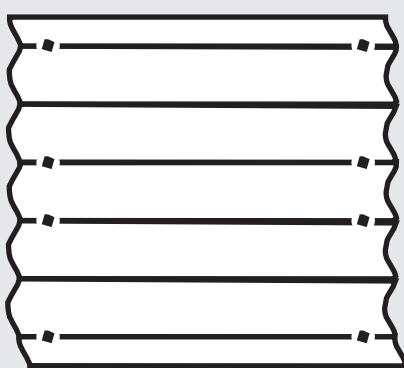

- 2 x 
- 4 x 
- 10 x 

ASSEMBLY INSTRUCTION

SPECIAL SHAPES

Pentagon

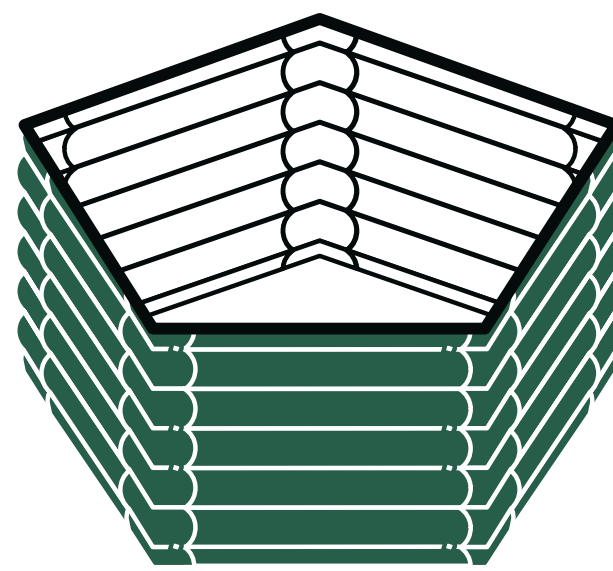
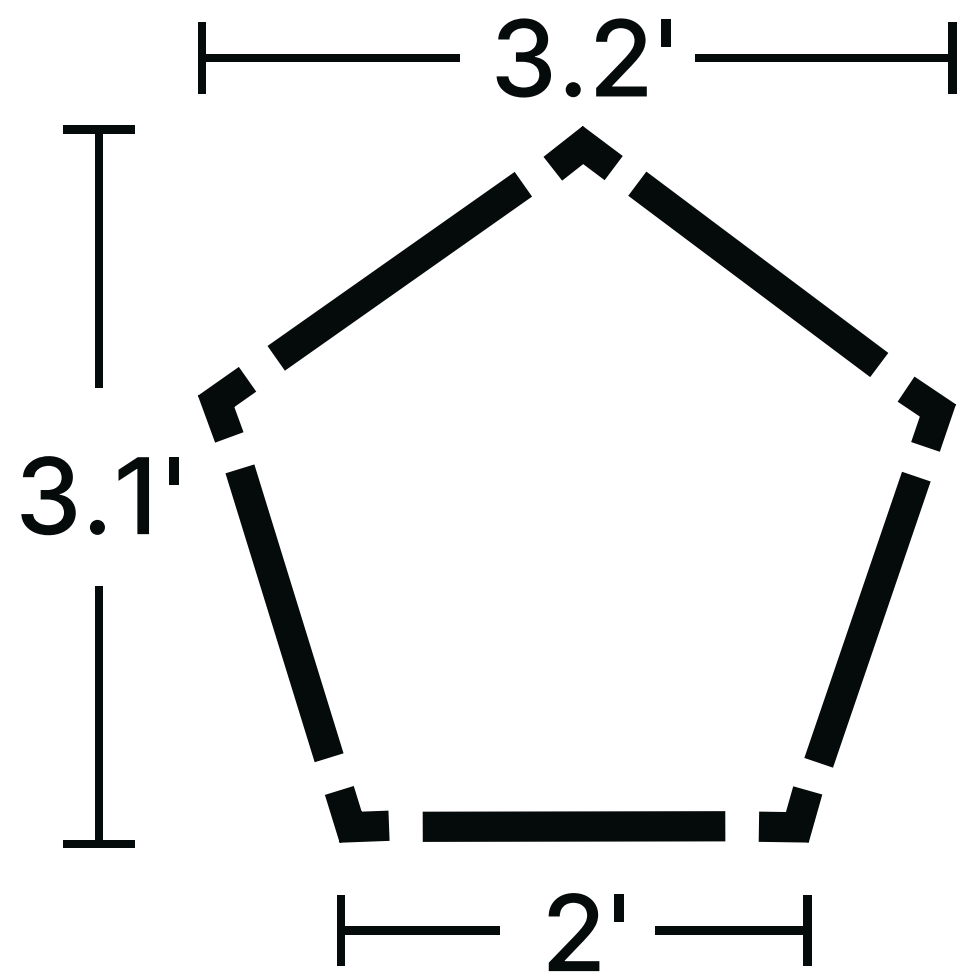

5 x



5 x

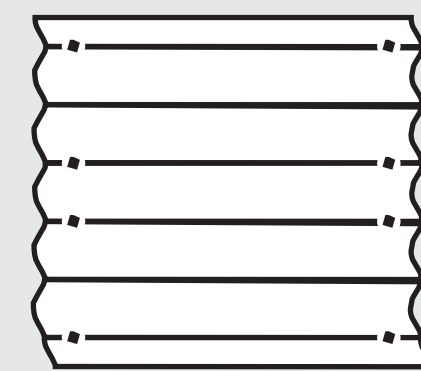

Hexagon

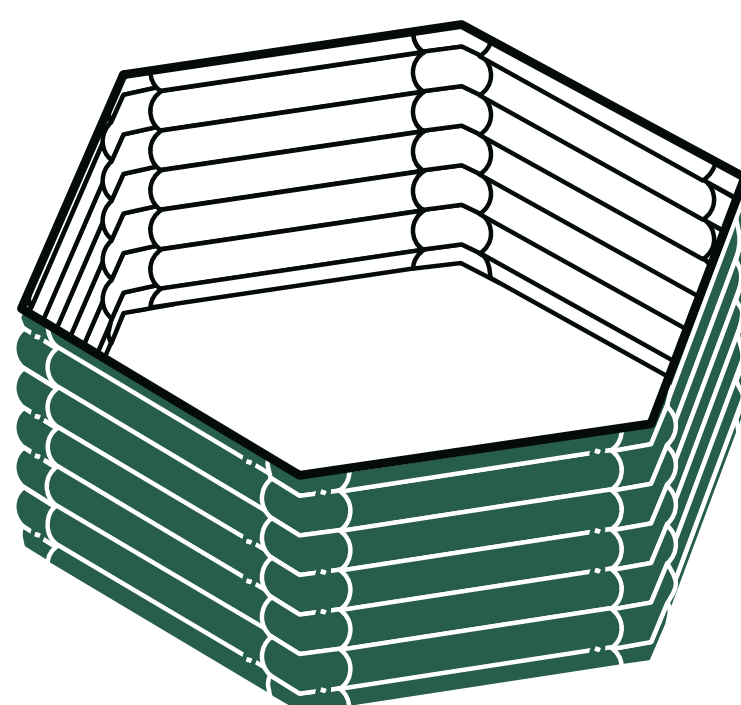
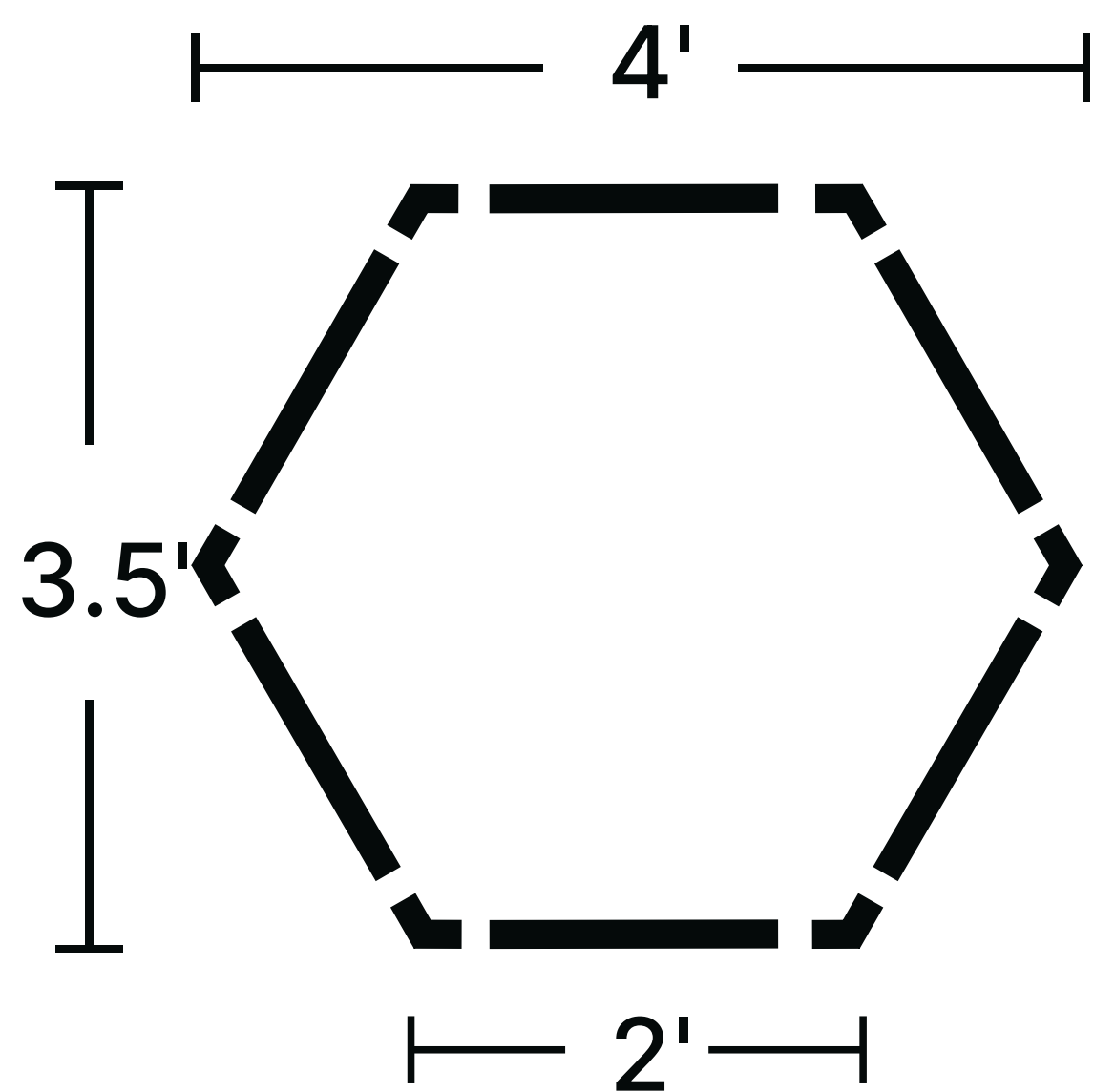

6 x

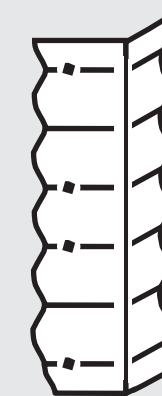

6 x

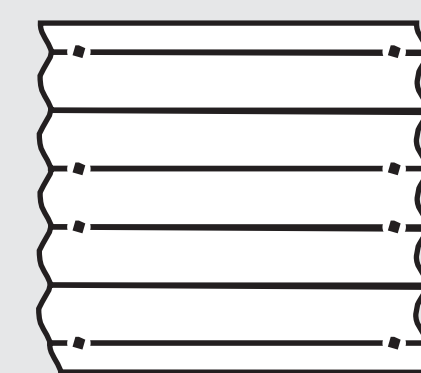

ASSEMBLY INSTRUCTION

SPECIAL SHAPES

Tiered

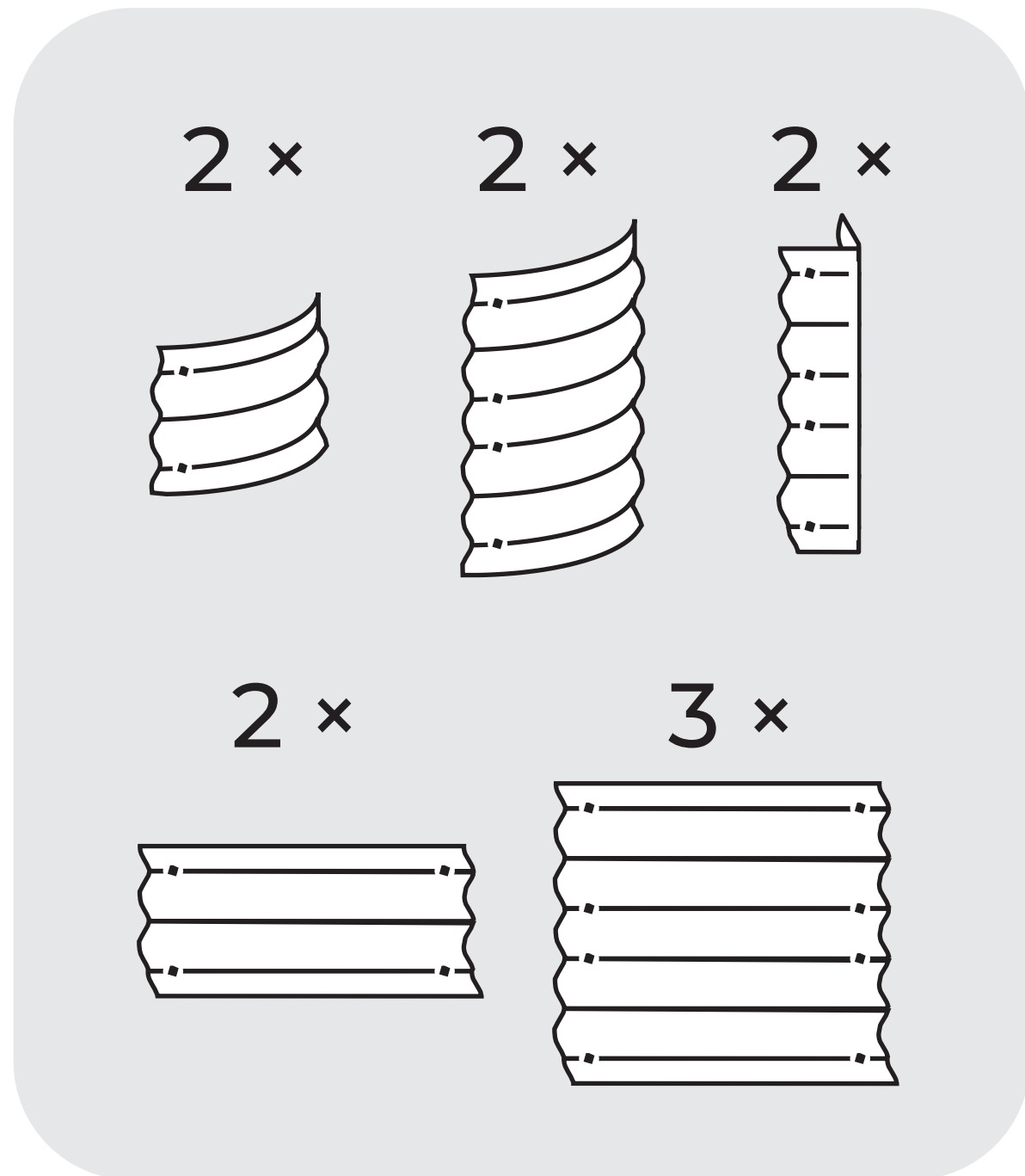
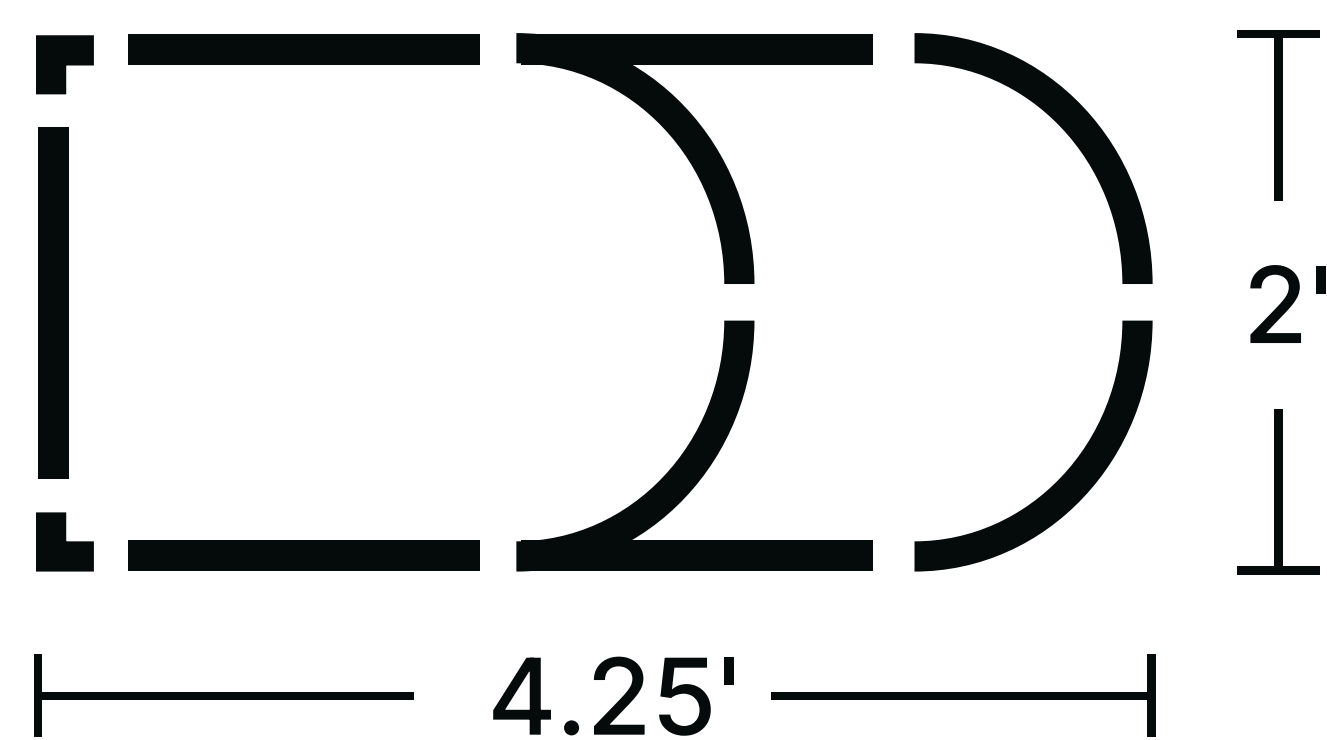

①



Assemble one 8" side panel and one 8" corner panel.

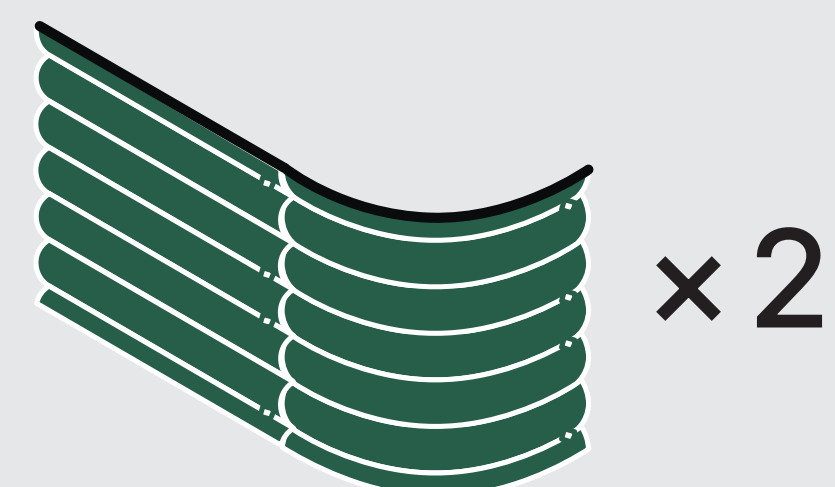

Assemble one 17" side panel and one 17" corner panel.

②

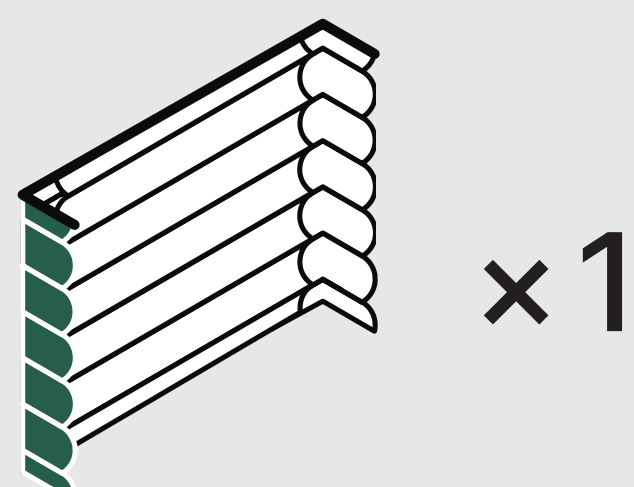

Assemble one 17" side panel and 2 pcs of straight corner panels.

③

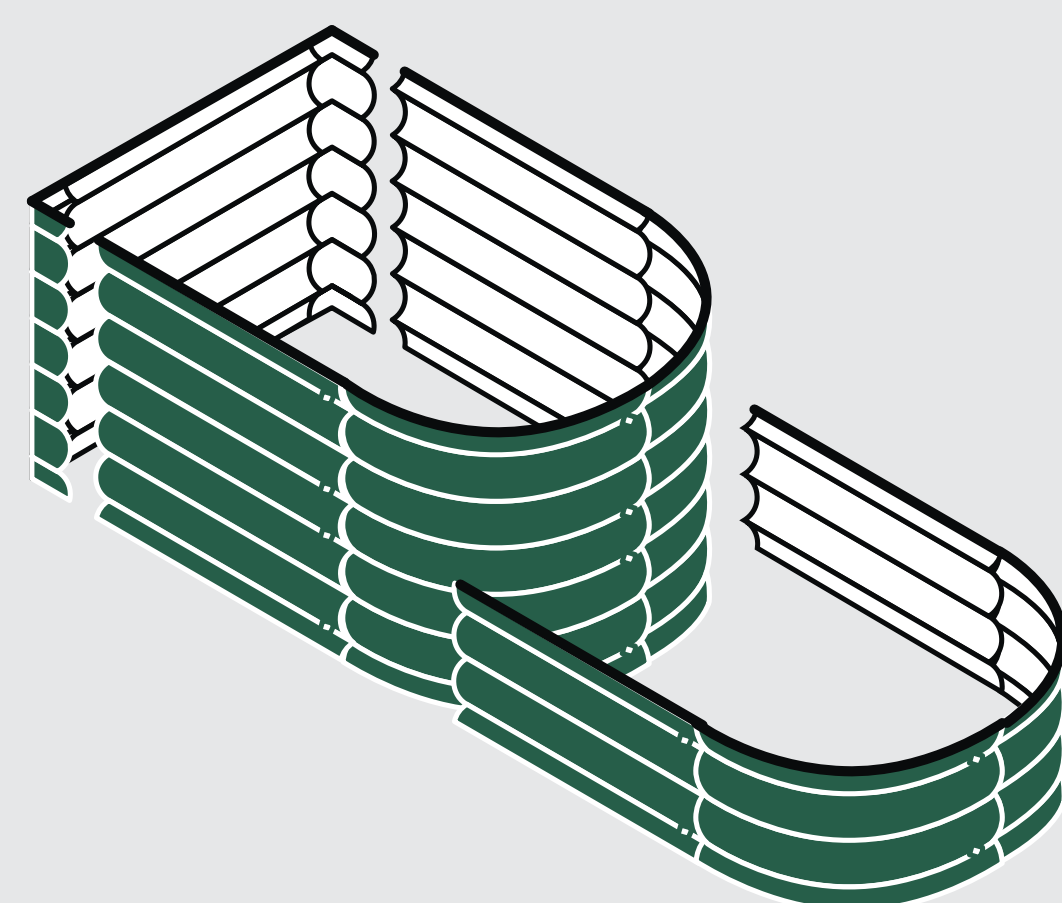

Put them together as shown on the picture.

ASSEMBLY INSTRUCTION

SPECIAL SHAPES

Castle

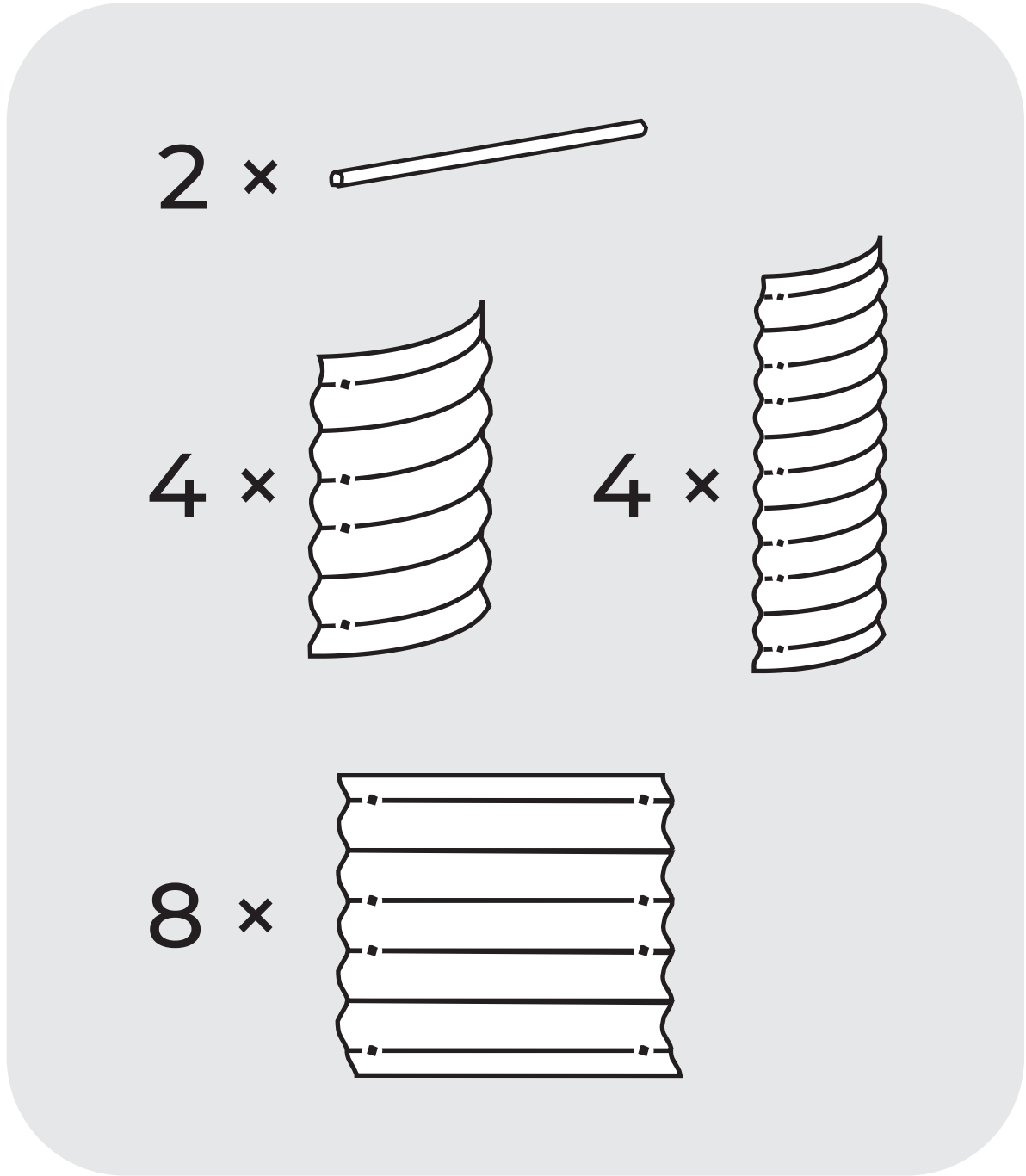
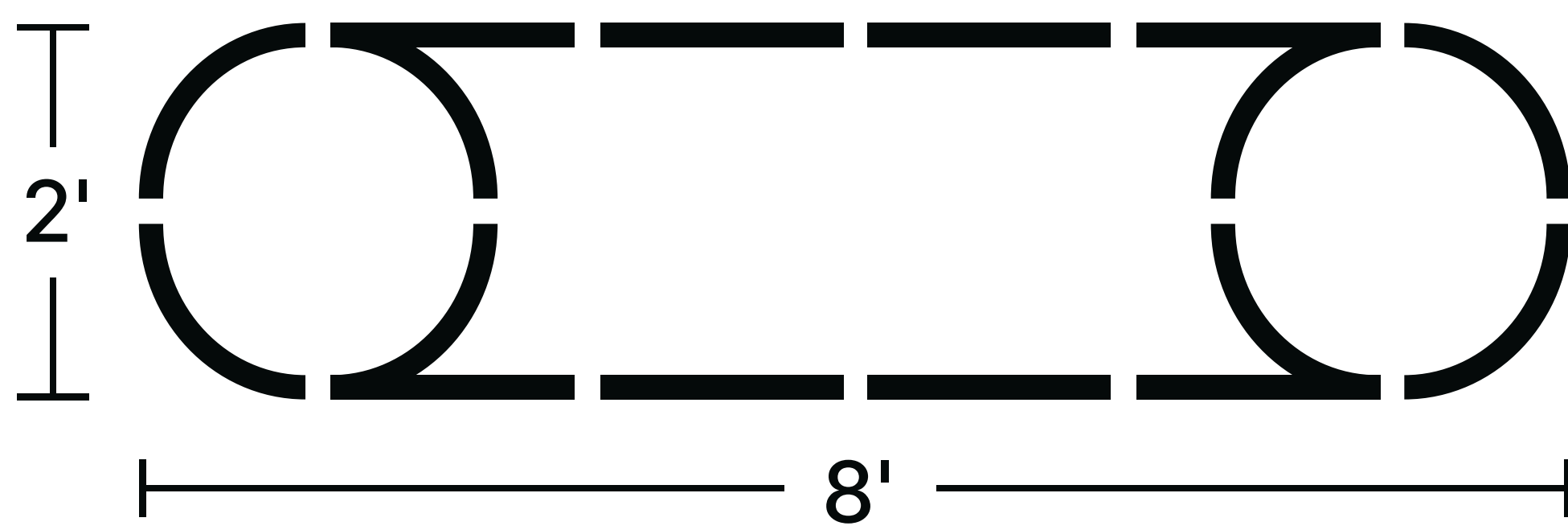

①

× 2 Assemble two 32" corner panels.

× 2 Assemble two 17" corner panels.

②

× 2 Assemble four 17" side panels.

③

Put them together as shown on the picture.

ASSEMBLY INSTRUCTION

SPECIAL SHAPES

Heart Shaped

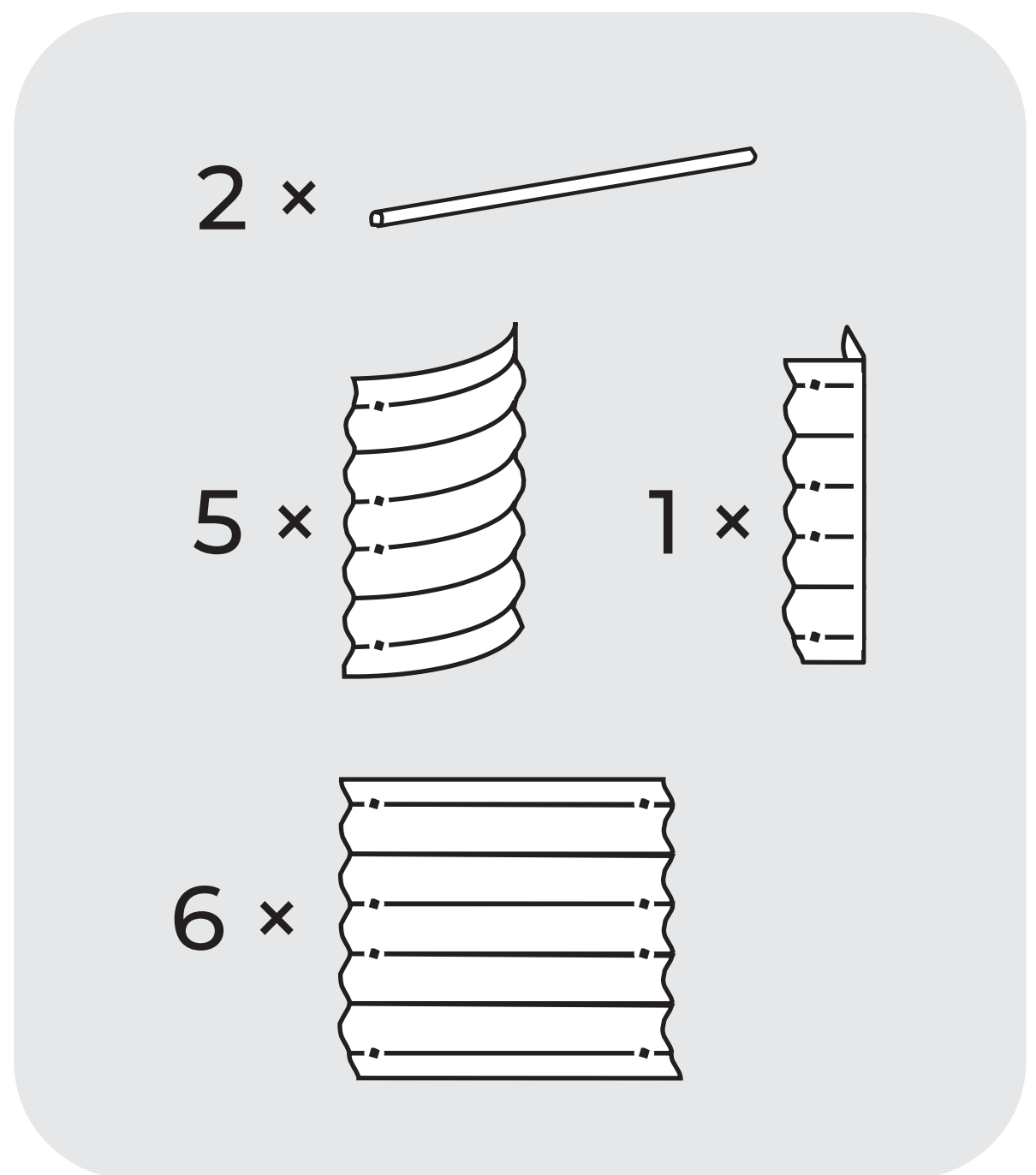
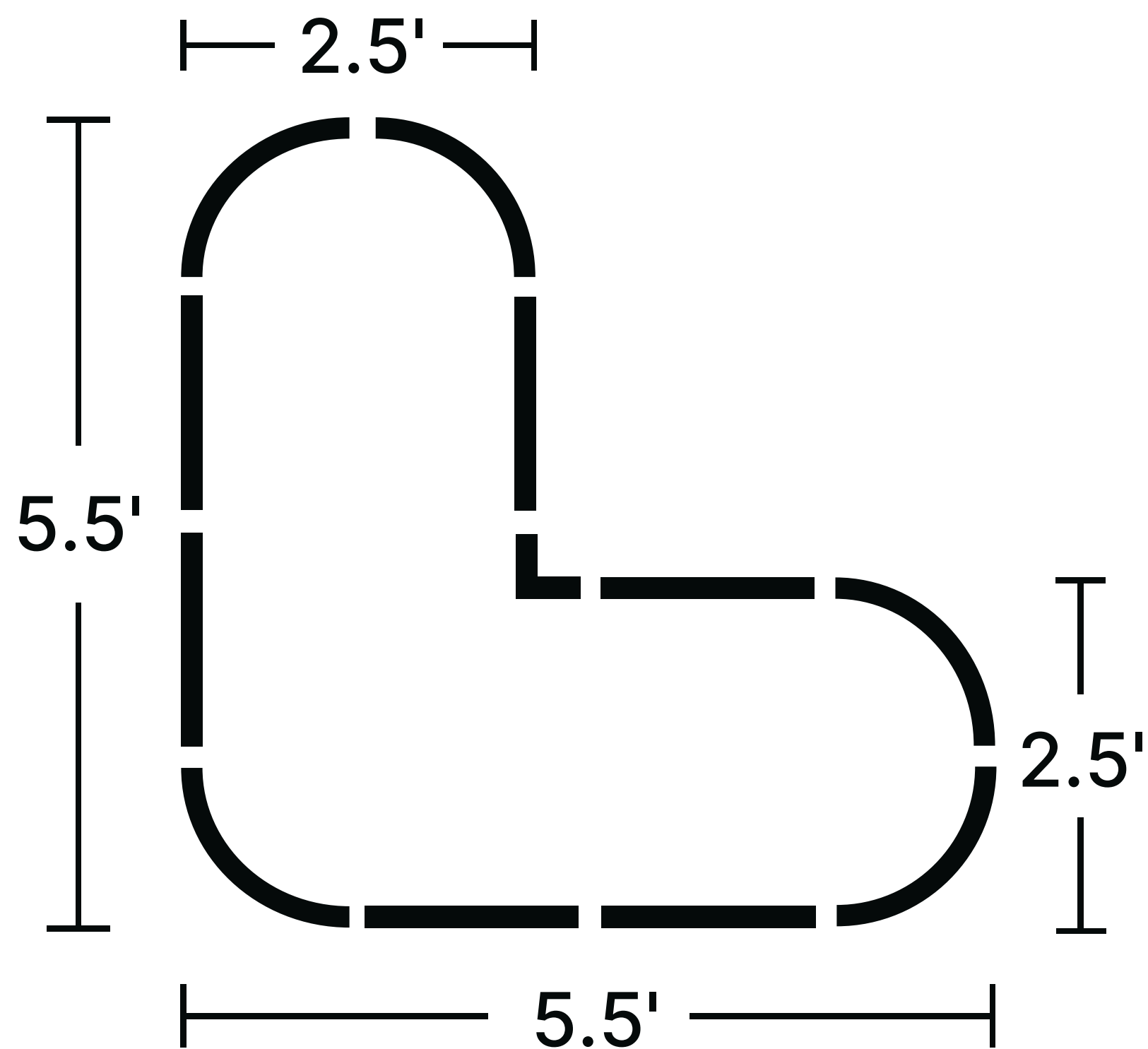

①

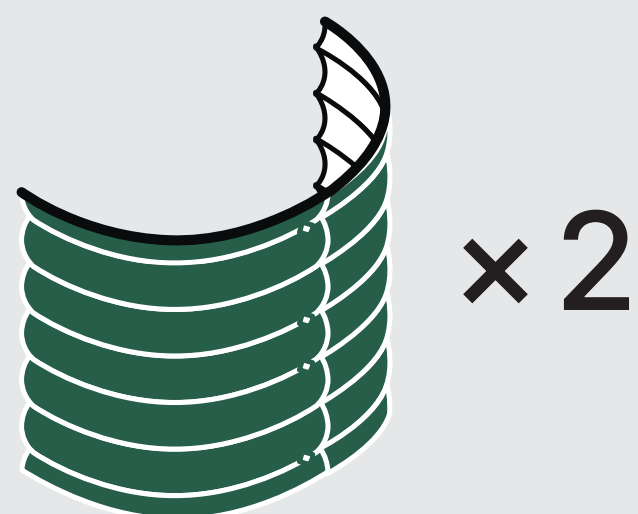

Assemble two corner panels.

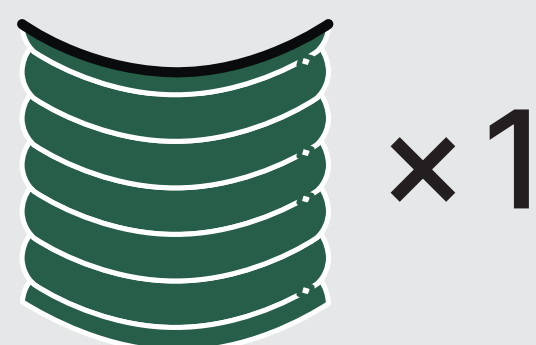

One corner panel

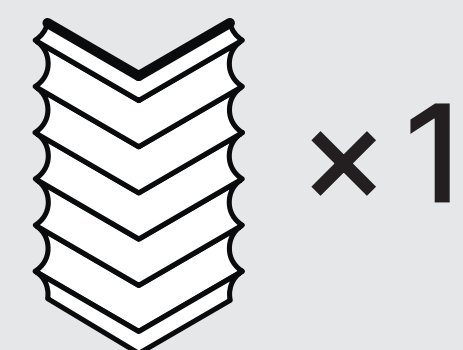

One straight corner panel.

②

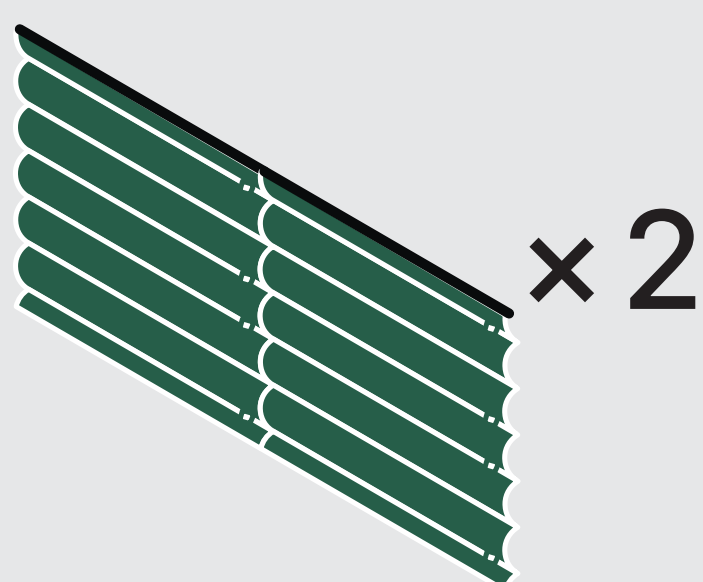

Assemble two side panels.

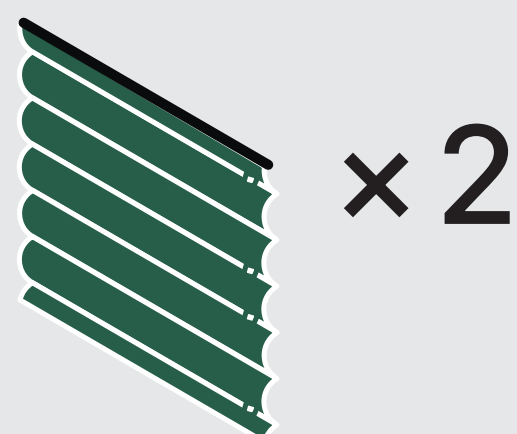

One side panel

③

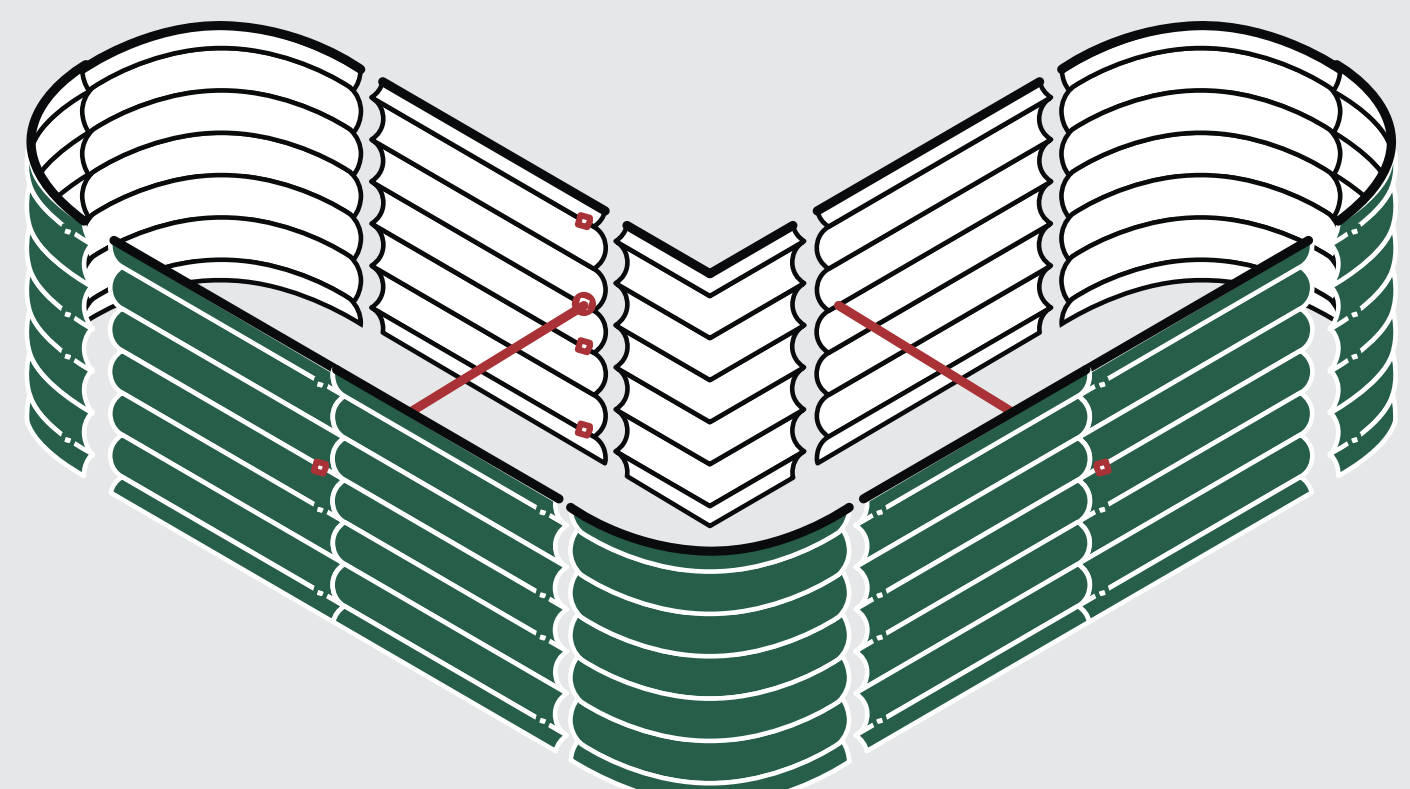

Put them together as shown on the picture.

ASSEMBLY INSTRUCTION

SPECIAL SHAPES

L Shaped

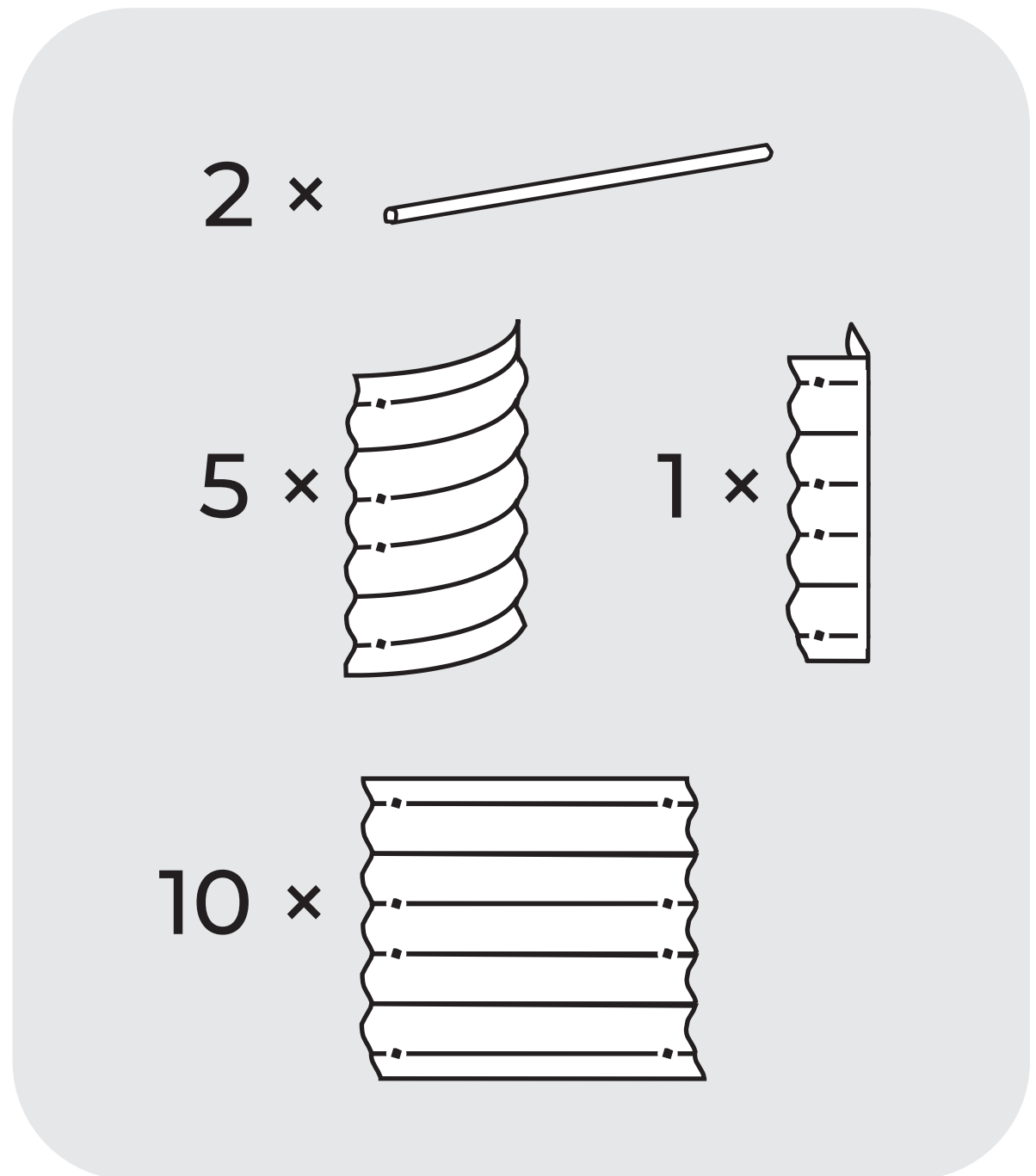
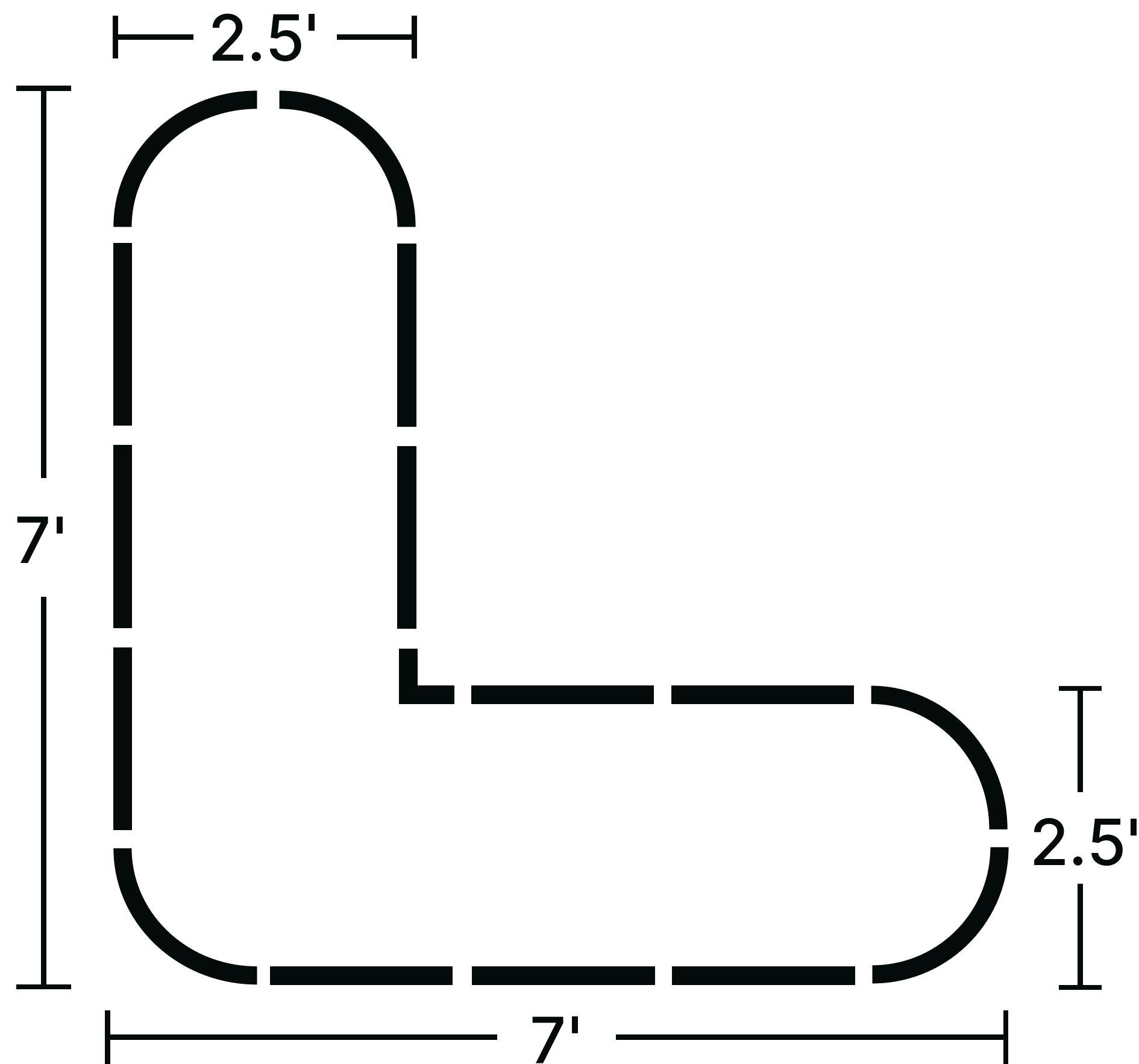

①



× 2

Assemble two corner panels.



× 1

One corner panel

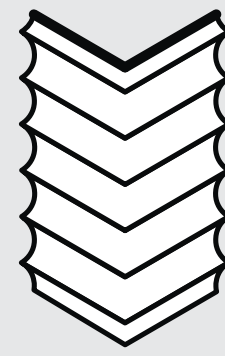

× 1

One straight corner panel

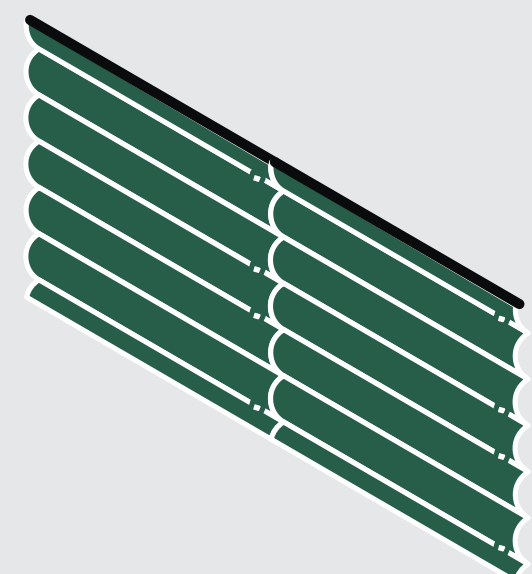

× 2

Assemble two side panels.

②

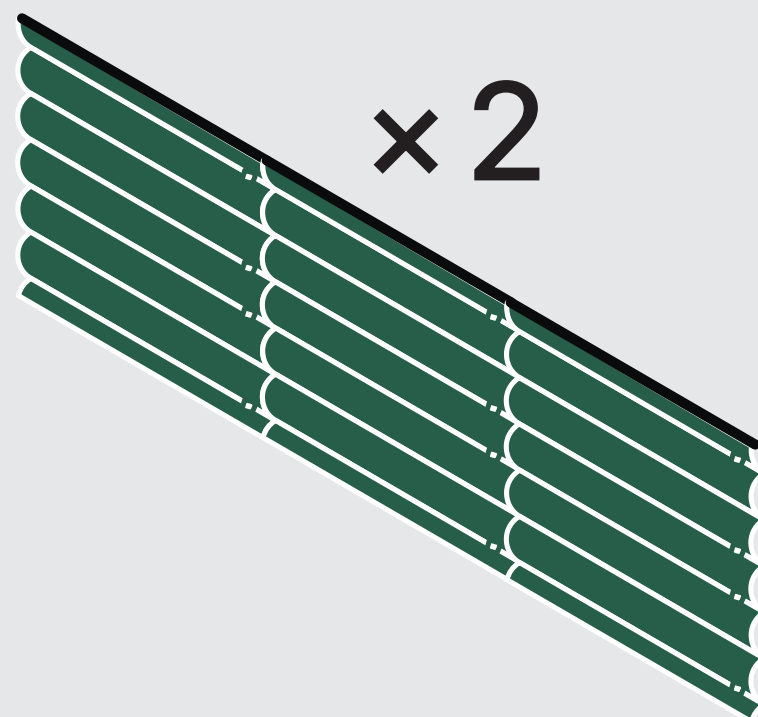

× 2

Assemble three side panels.

③

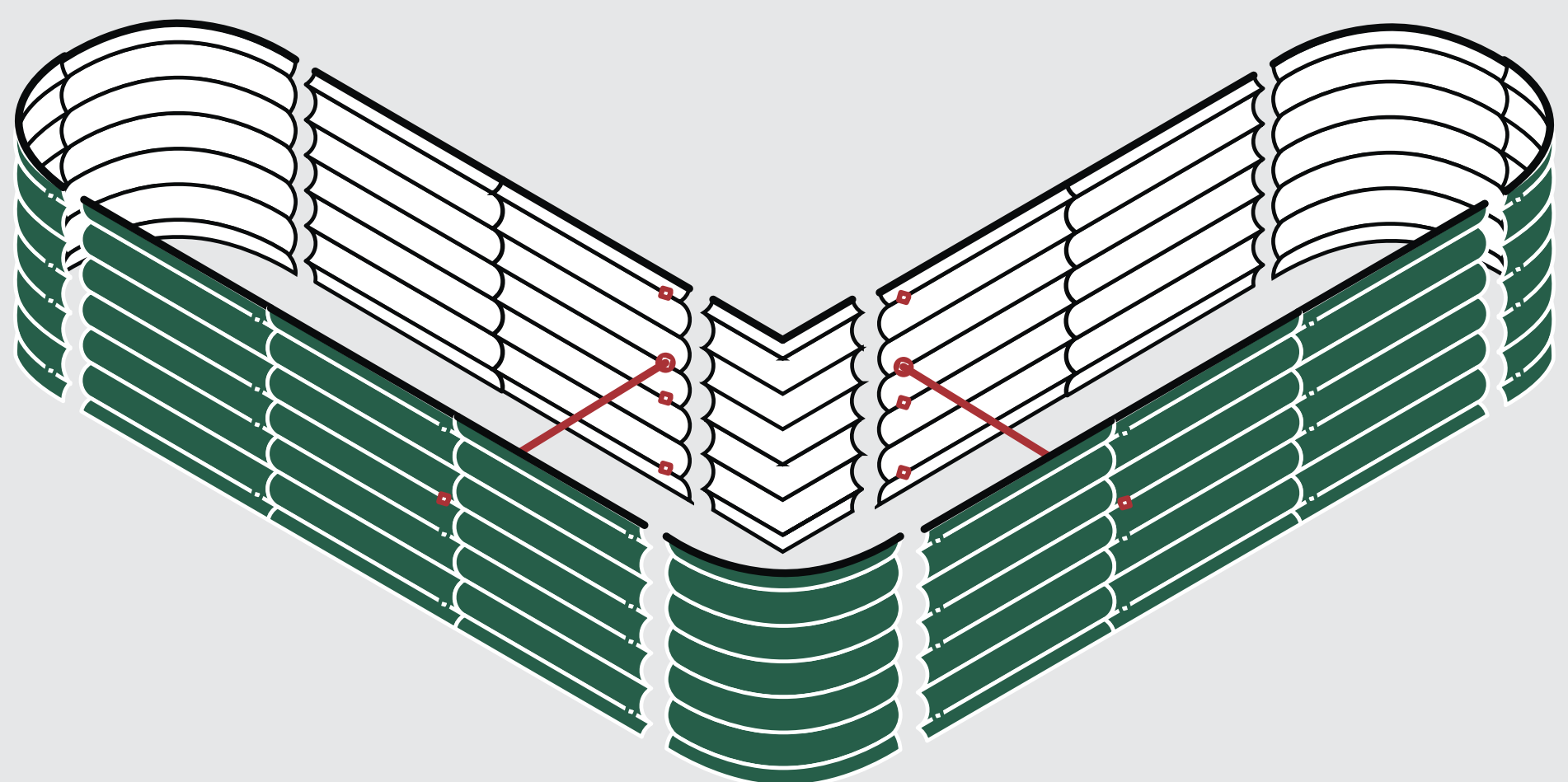

Put them together as shown on the picture.

ASSEMBLY INSTRUCTION

SPECIAL SHAPES

U Shaped Standard

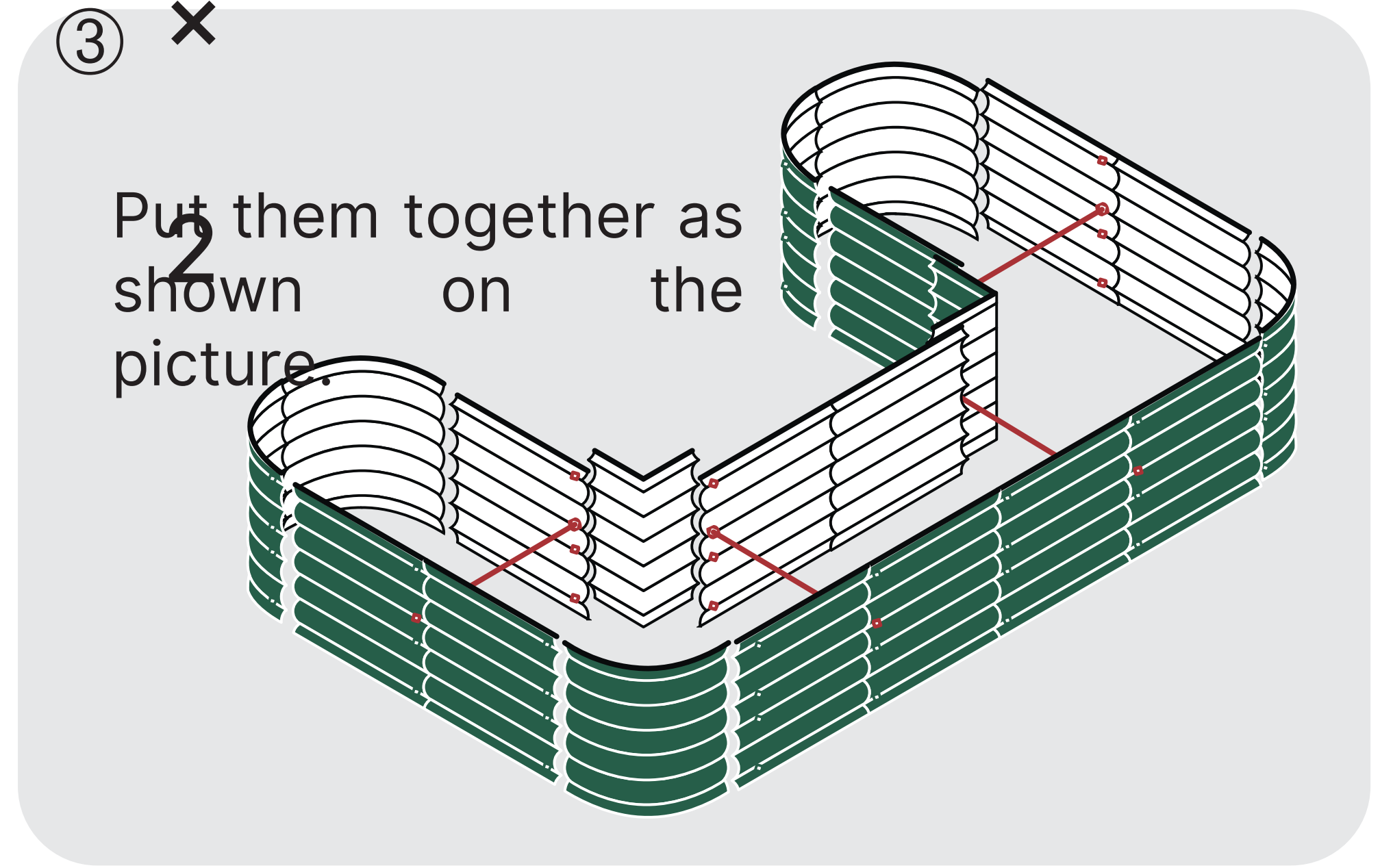
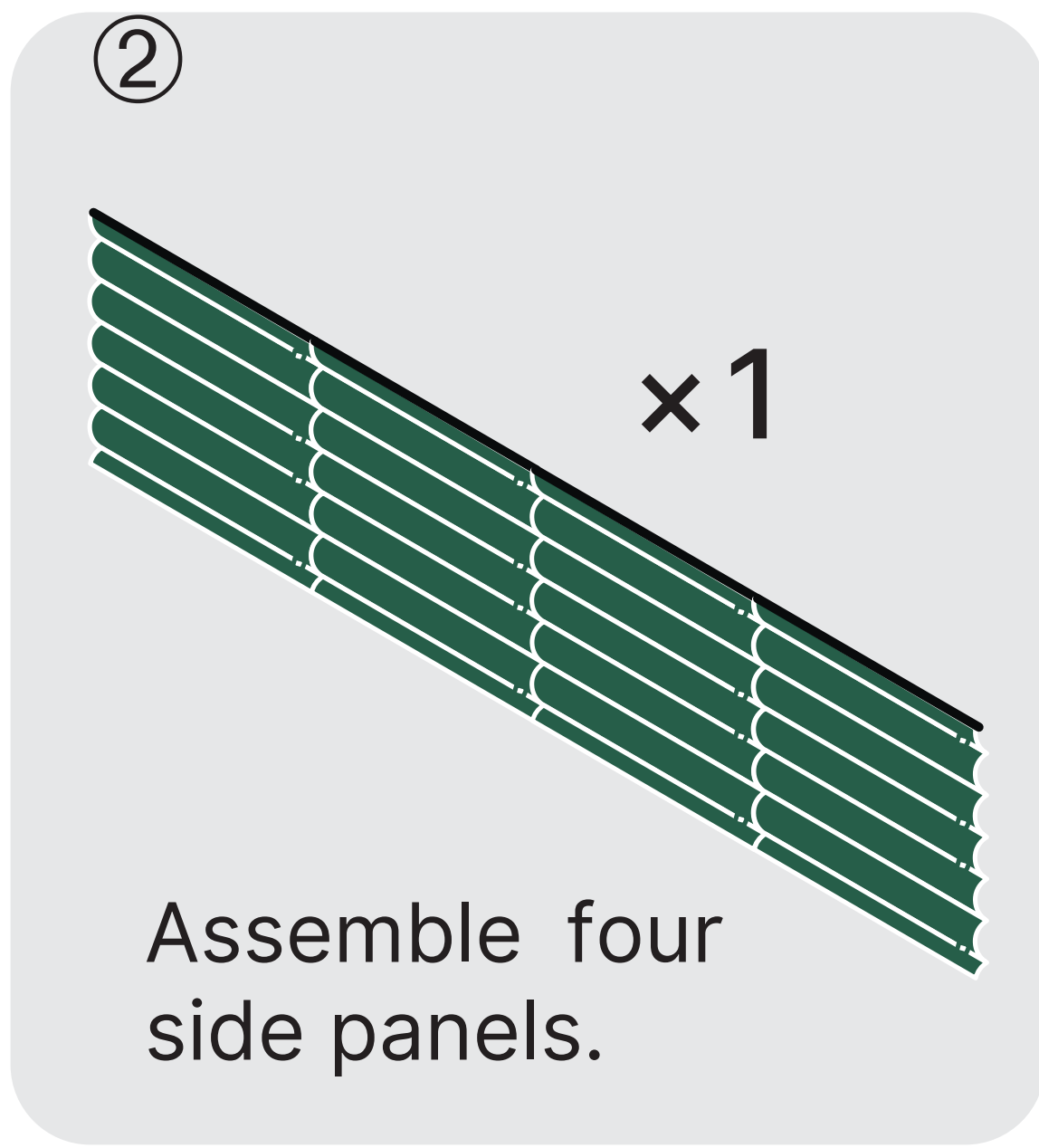
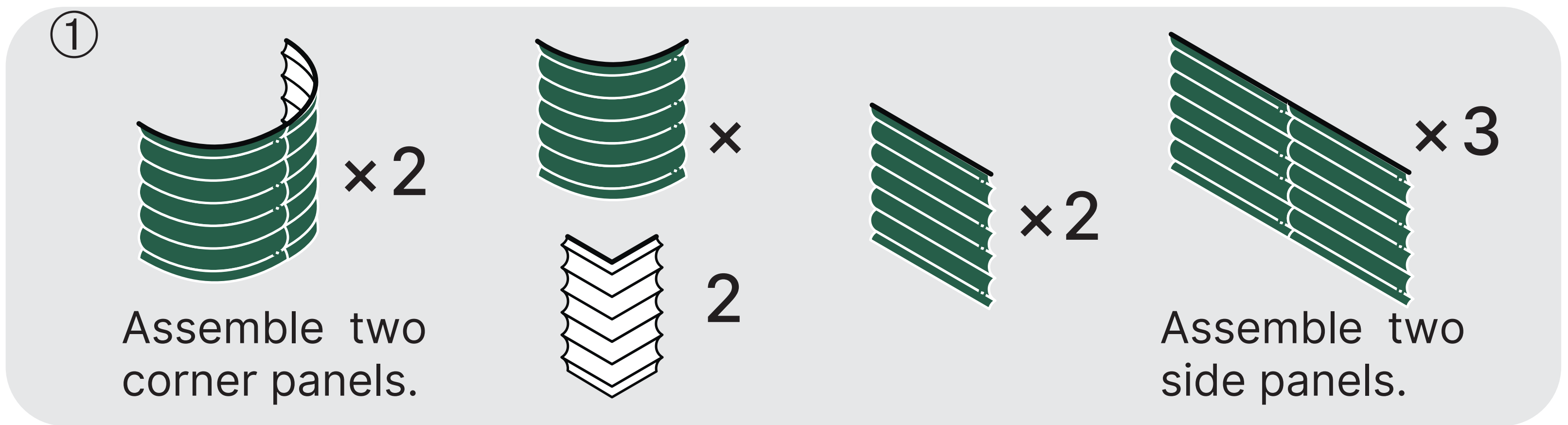
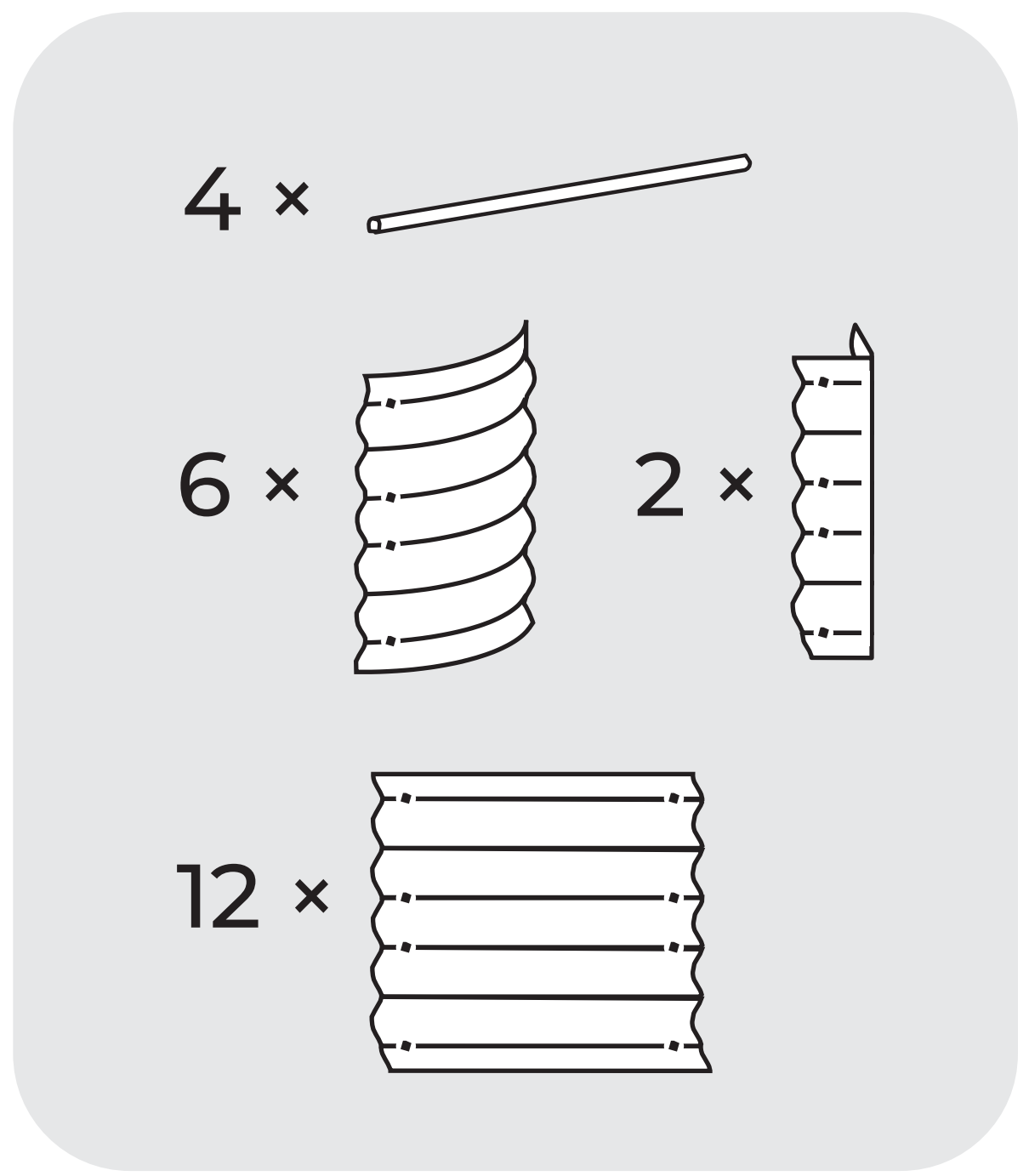
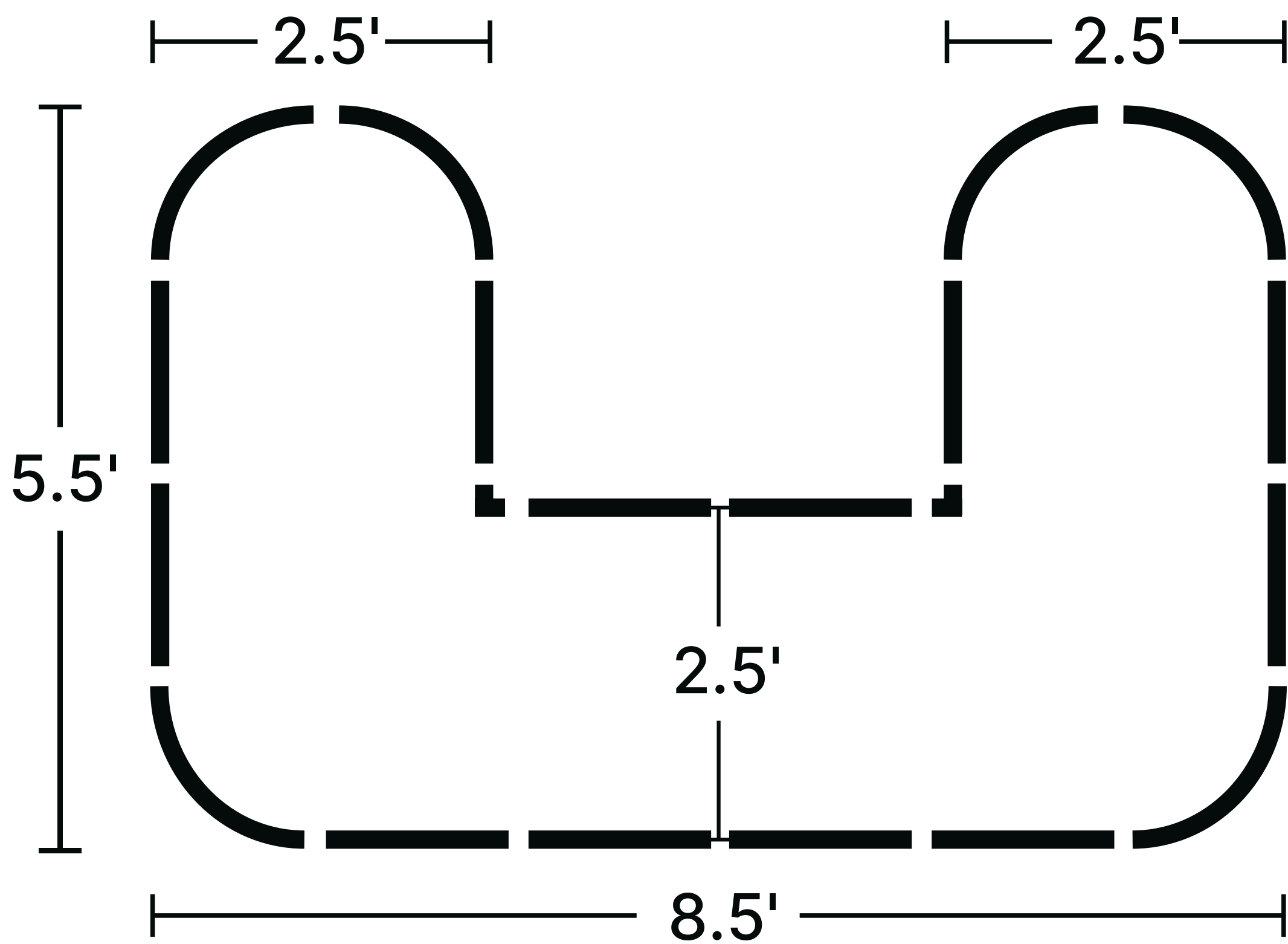

ASSEMBLY INSTRUCTION

SPECIAL SHAPES

U Shaped Large

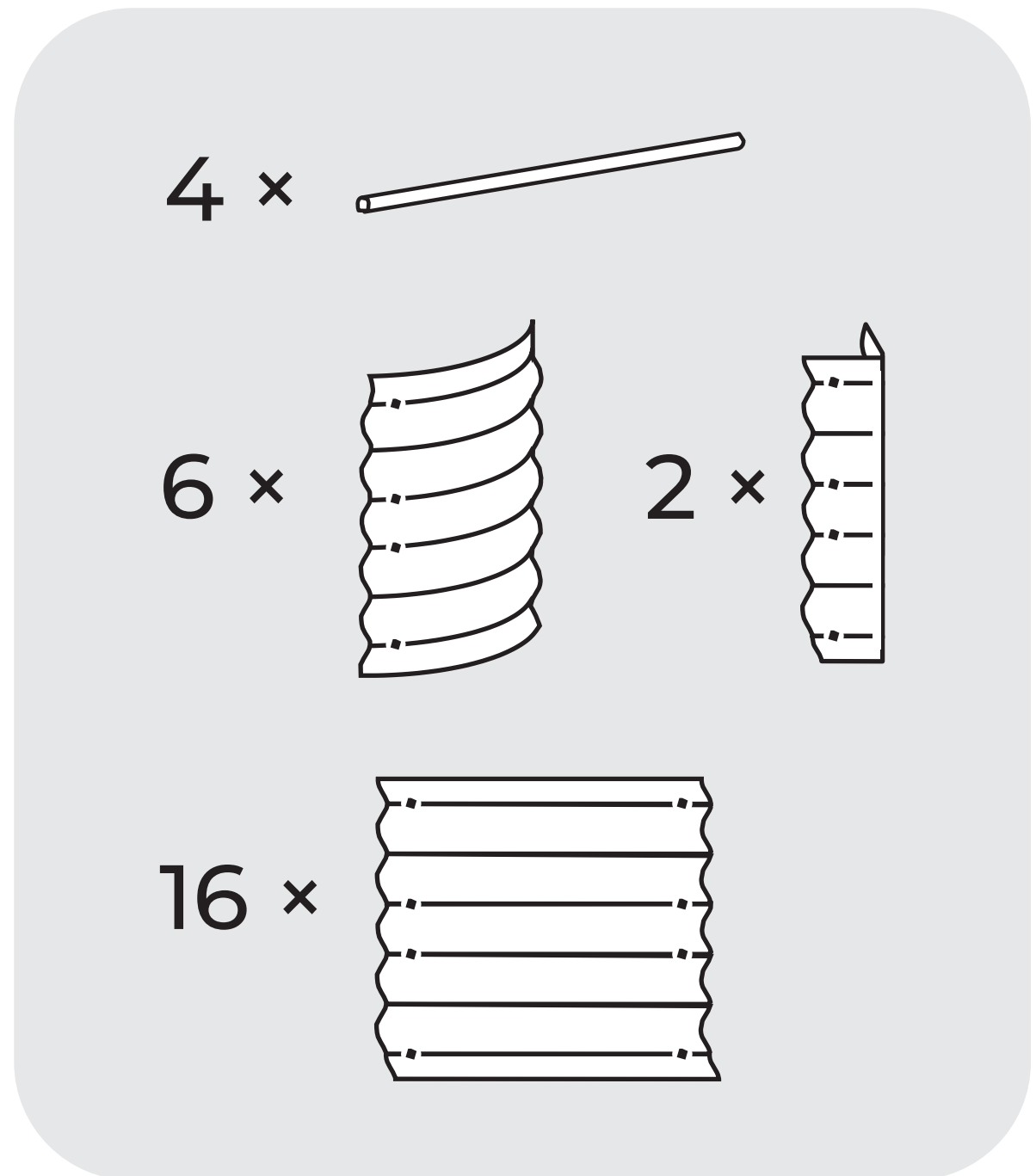
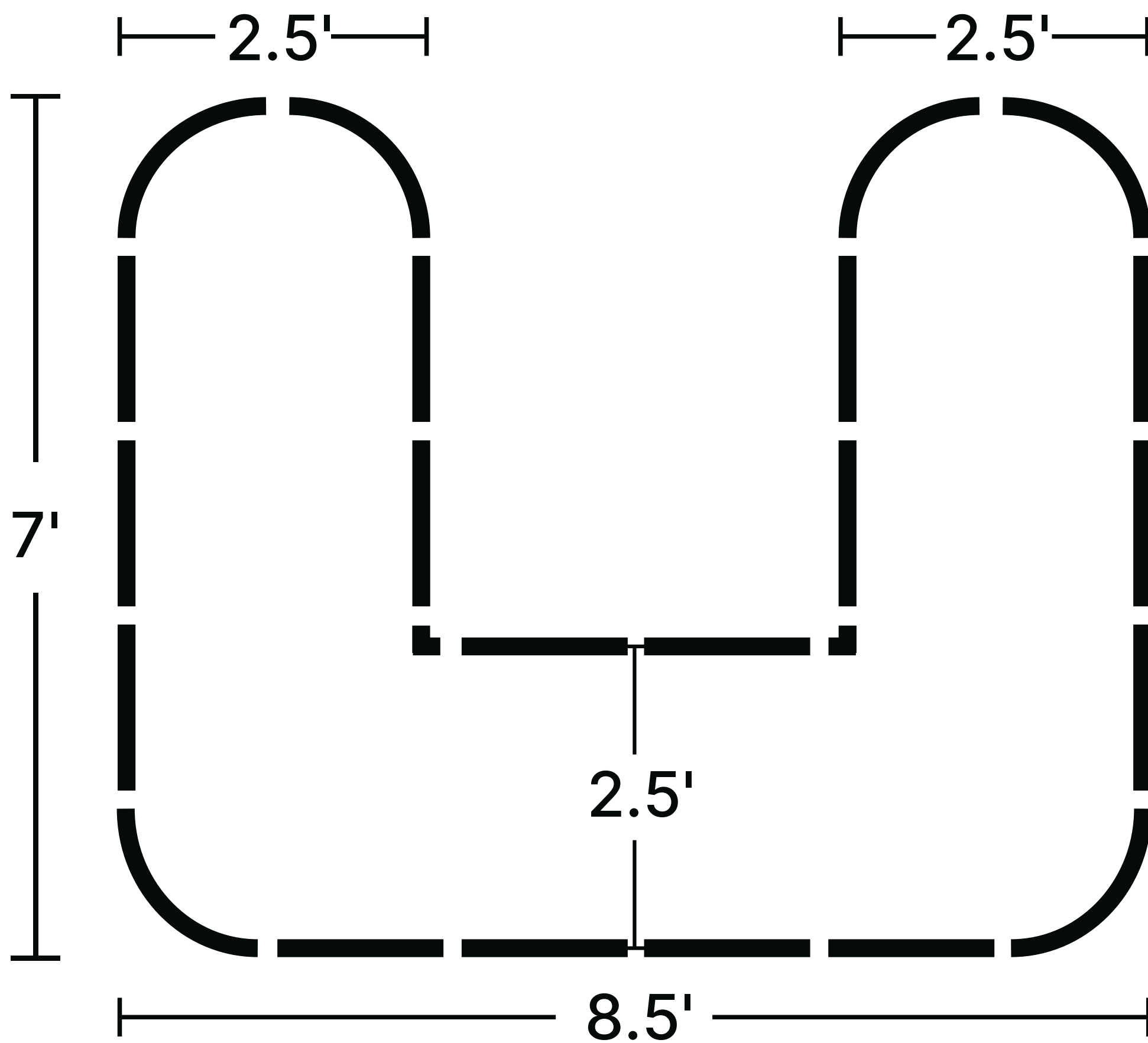

①

x2 x2 x2 x1

Assemble two corner panels. One corner panel One straight corner panel Assemble four side panels.

②

x 3 x

Assemble two side panels. Assemble three side panels.

③

Put them together as shown on the picture.

ASSEMBLY INSTRUCTION

SPECIAL SHAPES

2 Terraced

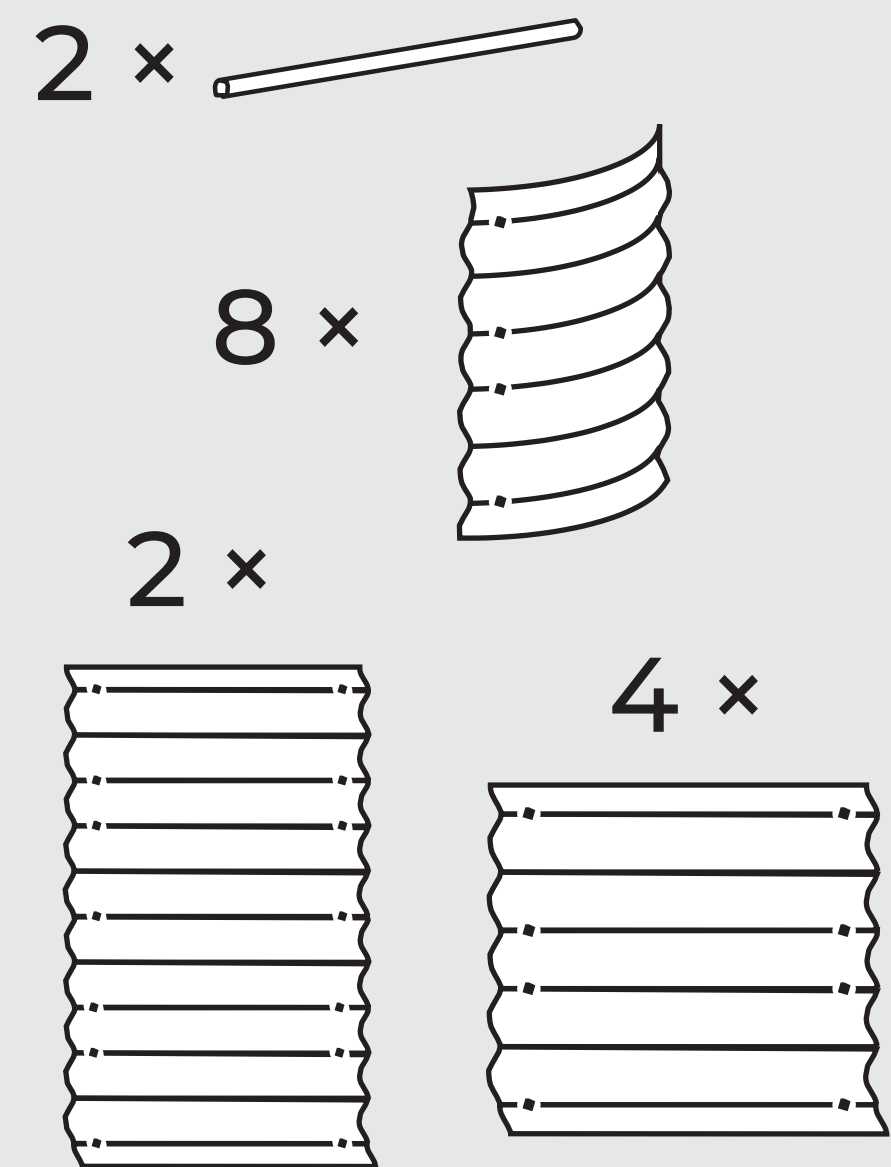
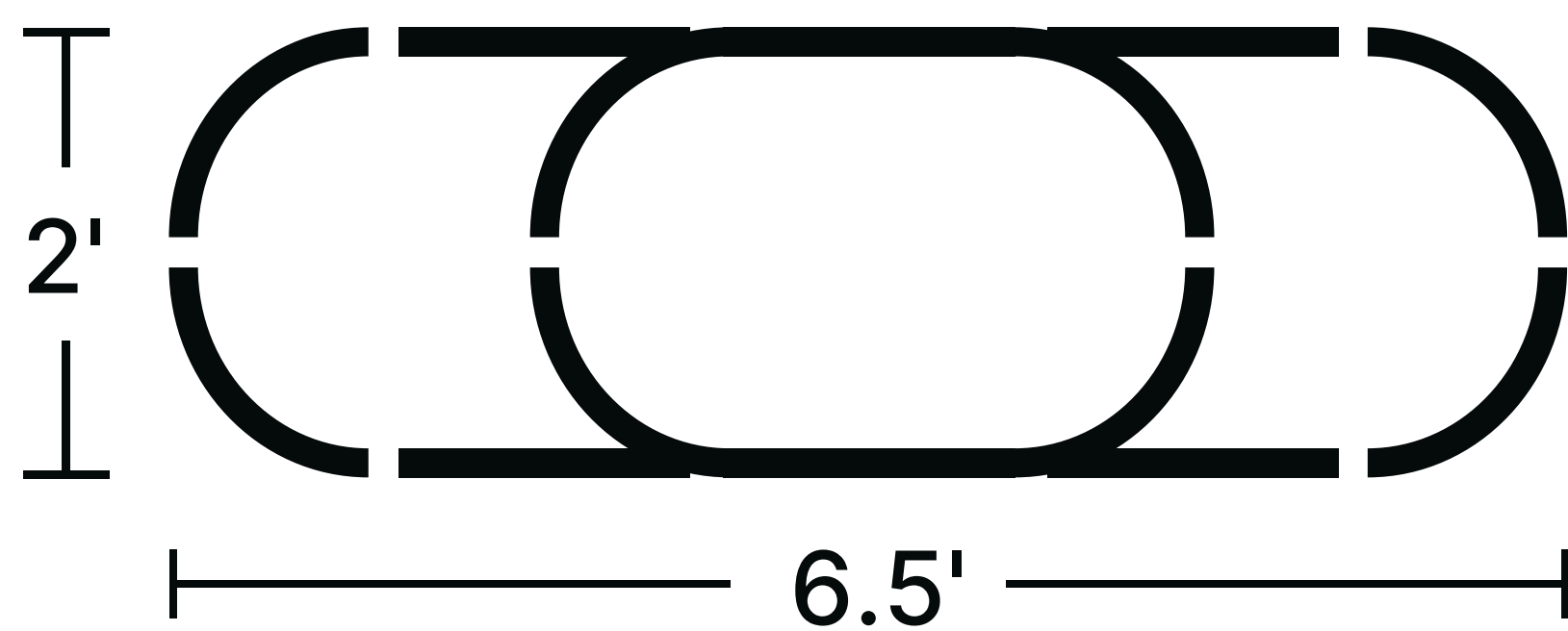

①



x 4

Assemble two 17" corner panels.

②

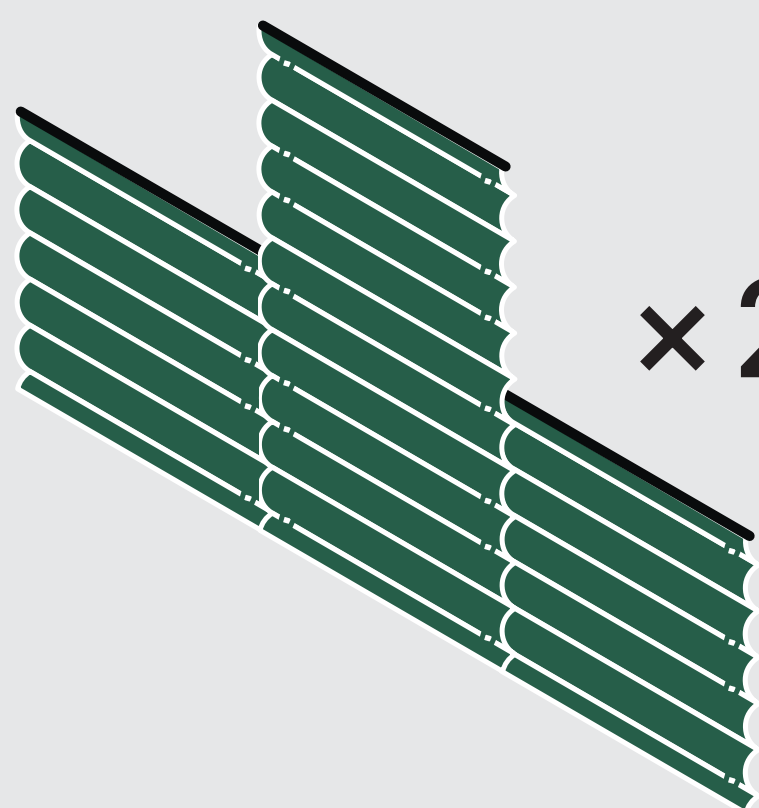

x 2

Assemble one 32" side panel and two 17" side panels.

③

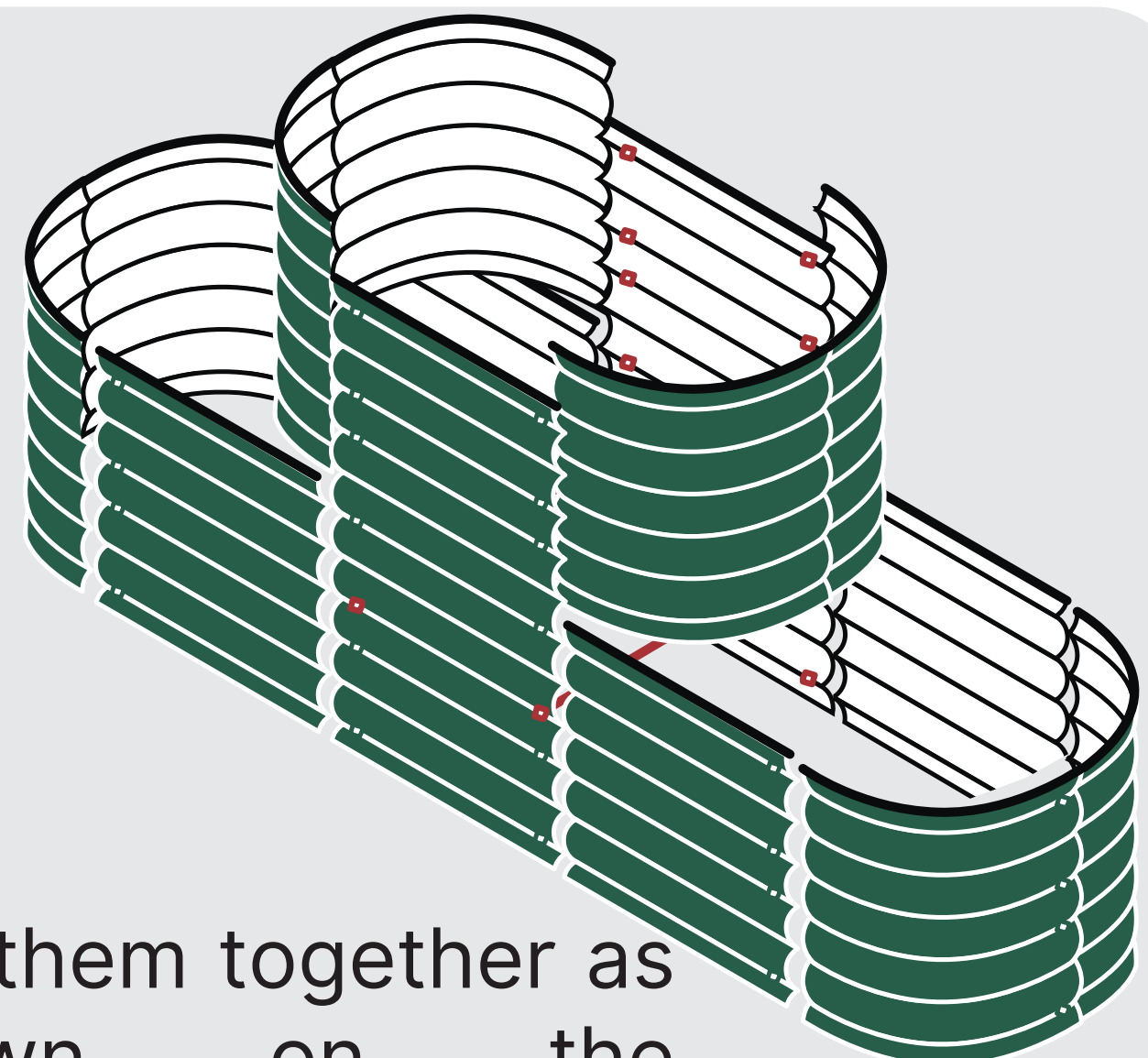

Put them together as shown on the picture.

ASSEMBLY INSTRUCTION

SPECIAL SHAPES

3 Terraced

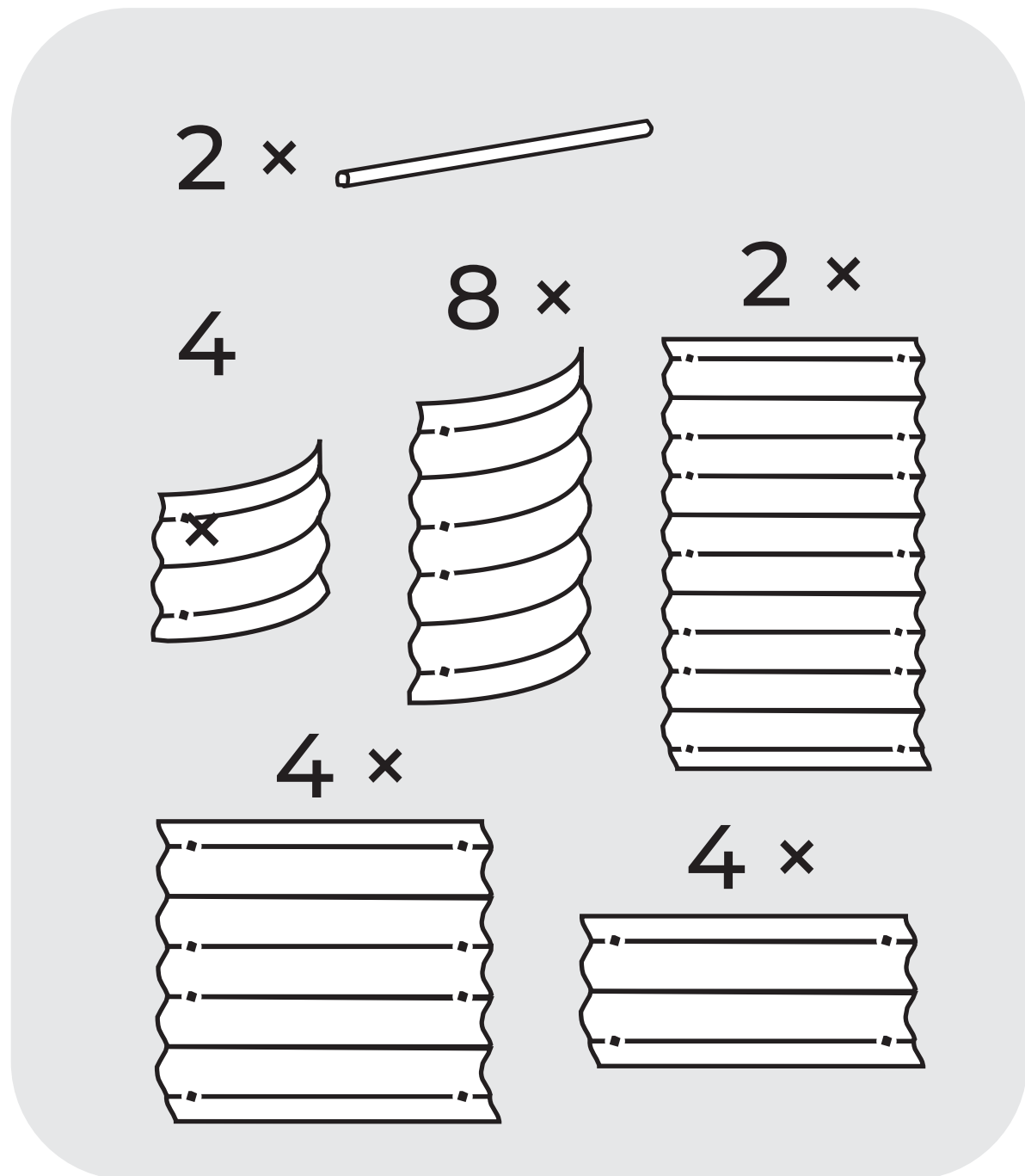
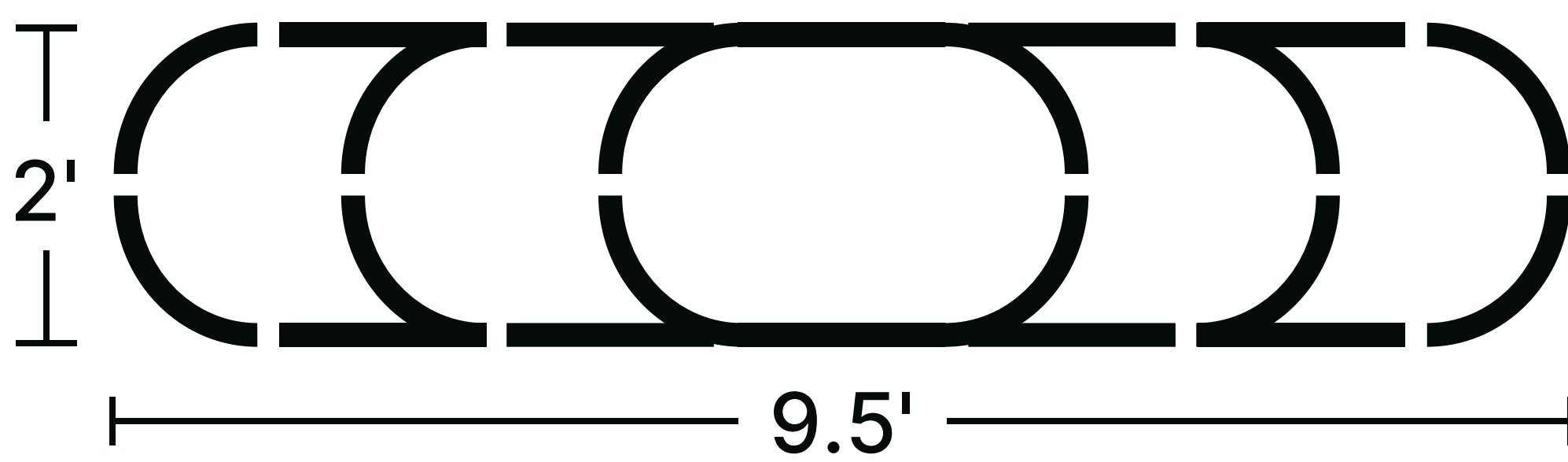

①

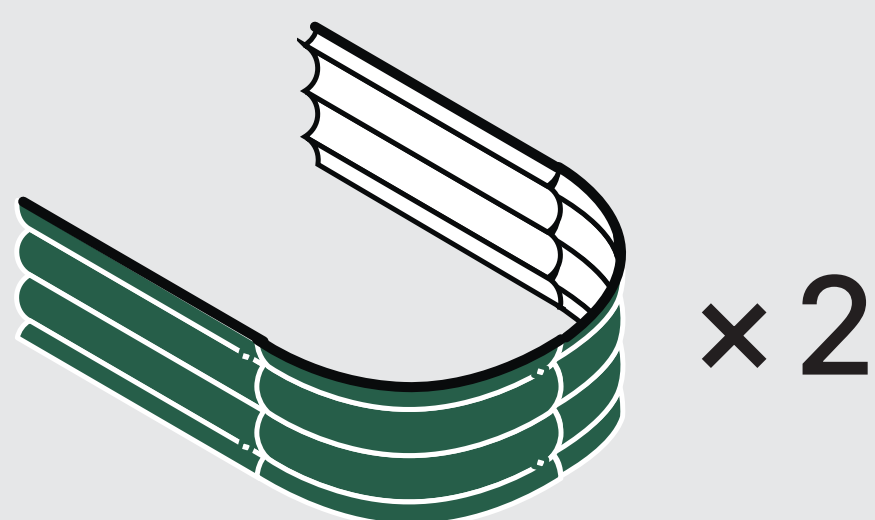

Assemble two 8" side panels and two 8" corner panels.



Assemble four 17" corner panels.

②

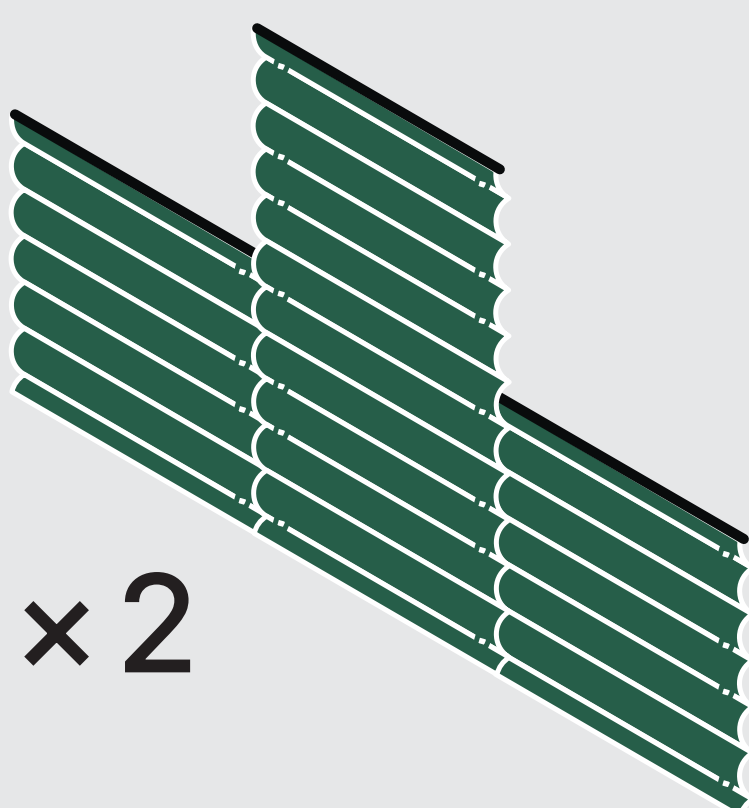

Assemble one 32" side panel and two 17" side panels.

③

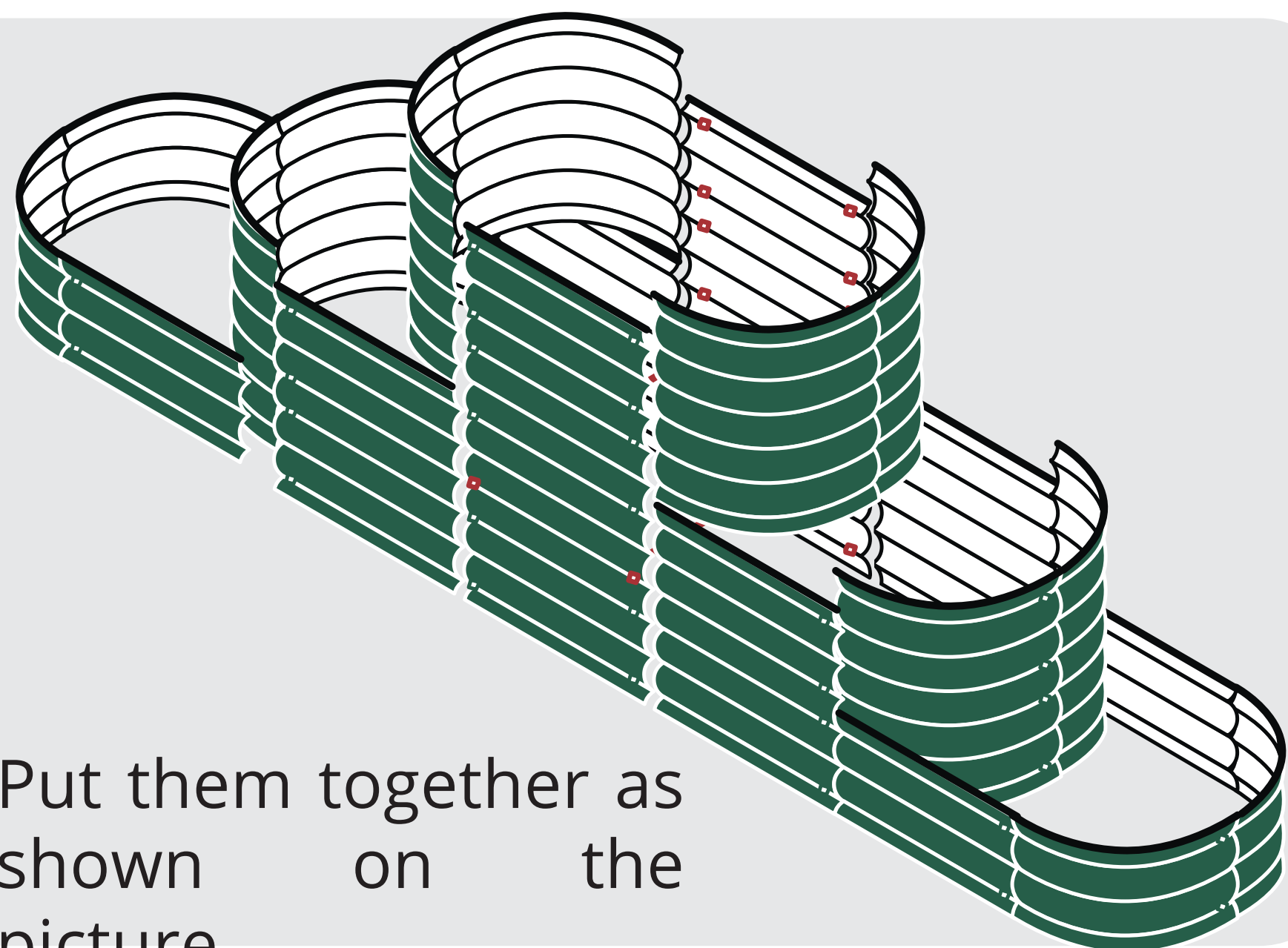

Put them together as shown on the picture.

ASSEMBLY INSTRUCTION

EXTENSION KIT

Extension Panels

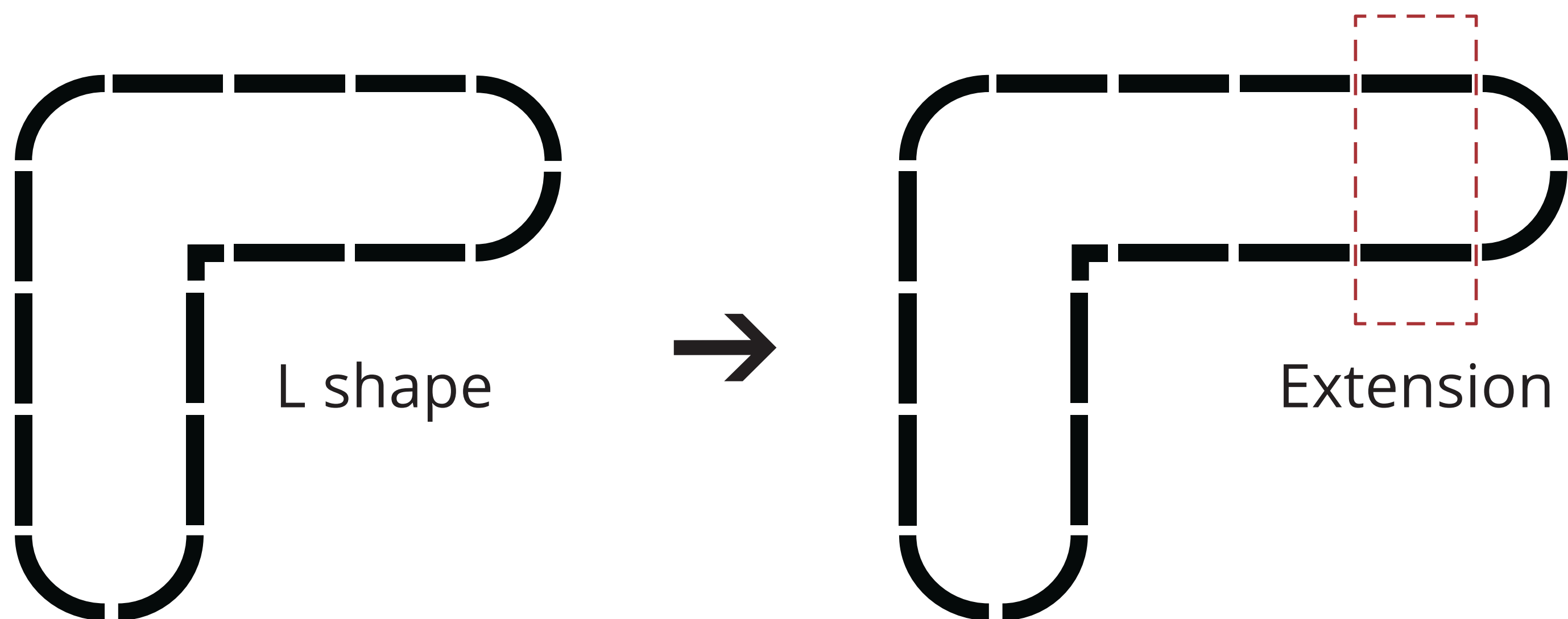

Extension Kit Package:



Extension Rod

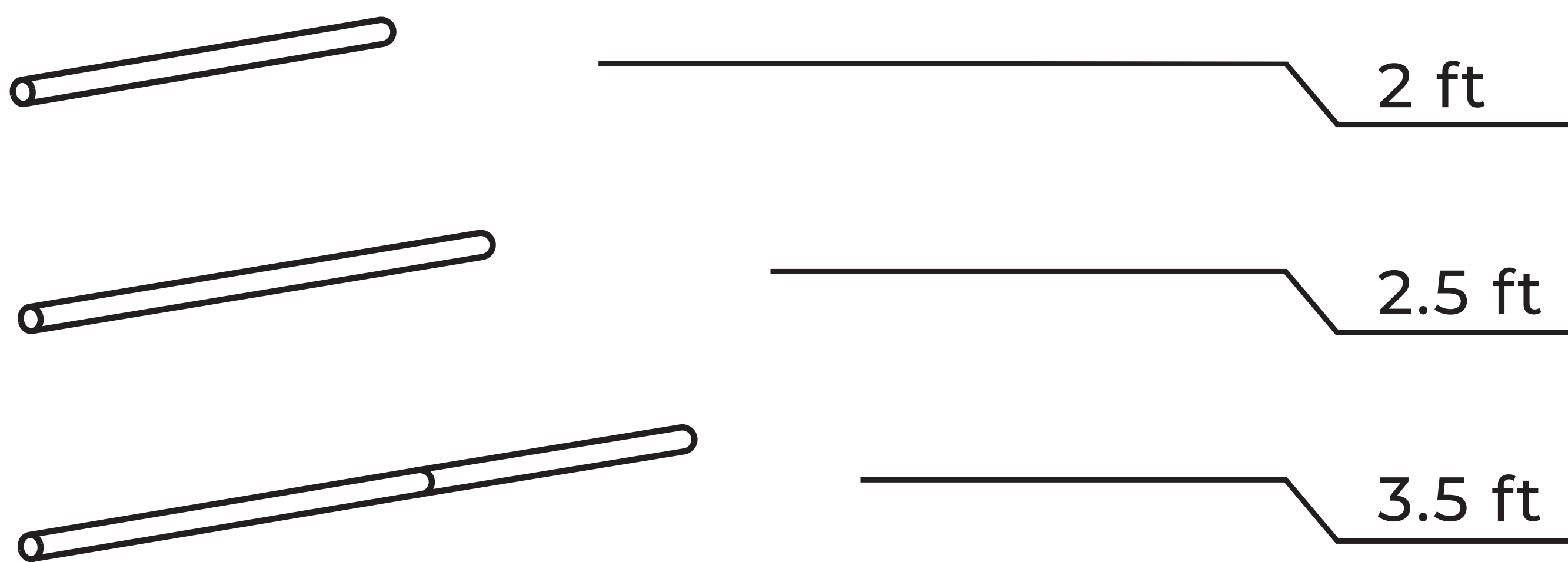

* There're two rods in every bracing rod package.

* 3.5ft rod is combined by one 2ft rod and one 1.5ft rod.

* Contact us if you're not sure about how to place rods on a customized shape.

ASSEMBLY INSTRUCTION

BRACING RODS PLACING

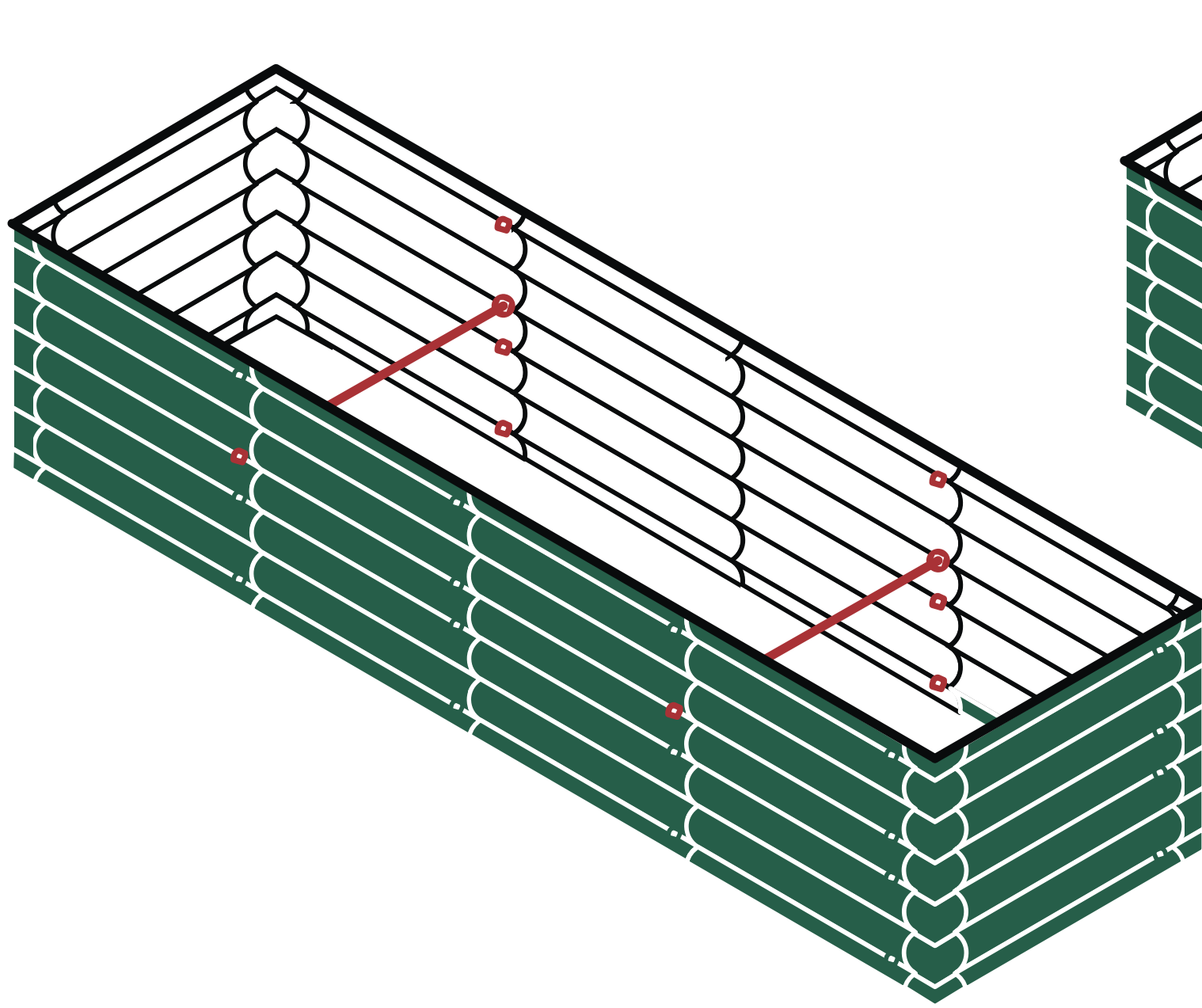

17 in.H × 6.5 ft.L × 2 ft.W
Bracing Rod: 2 × 2ft

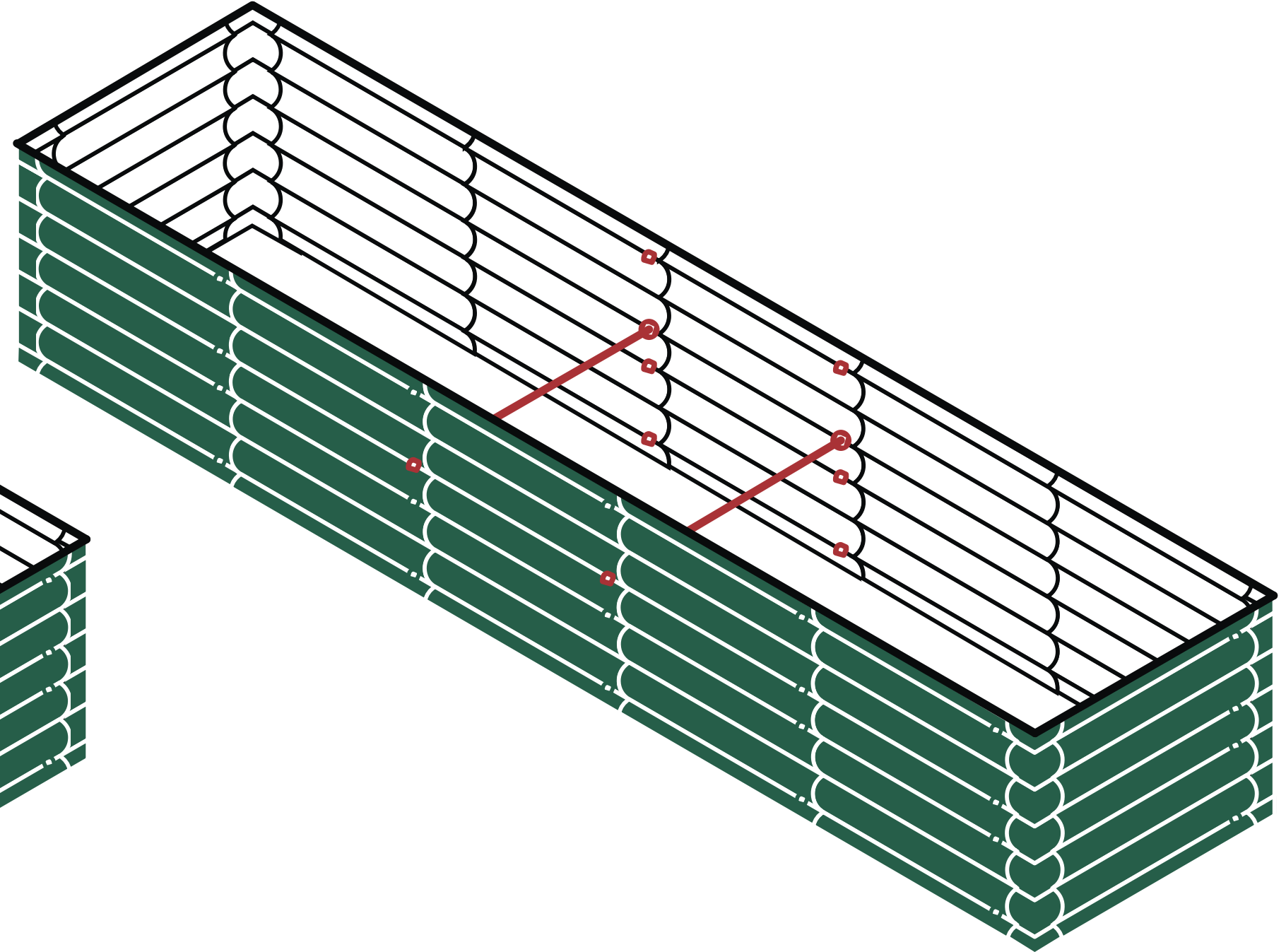

17 in.H × 8 ft.L × 2 ft.W
Bracing Rod: 2 × 2ft

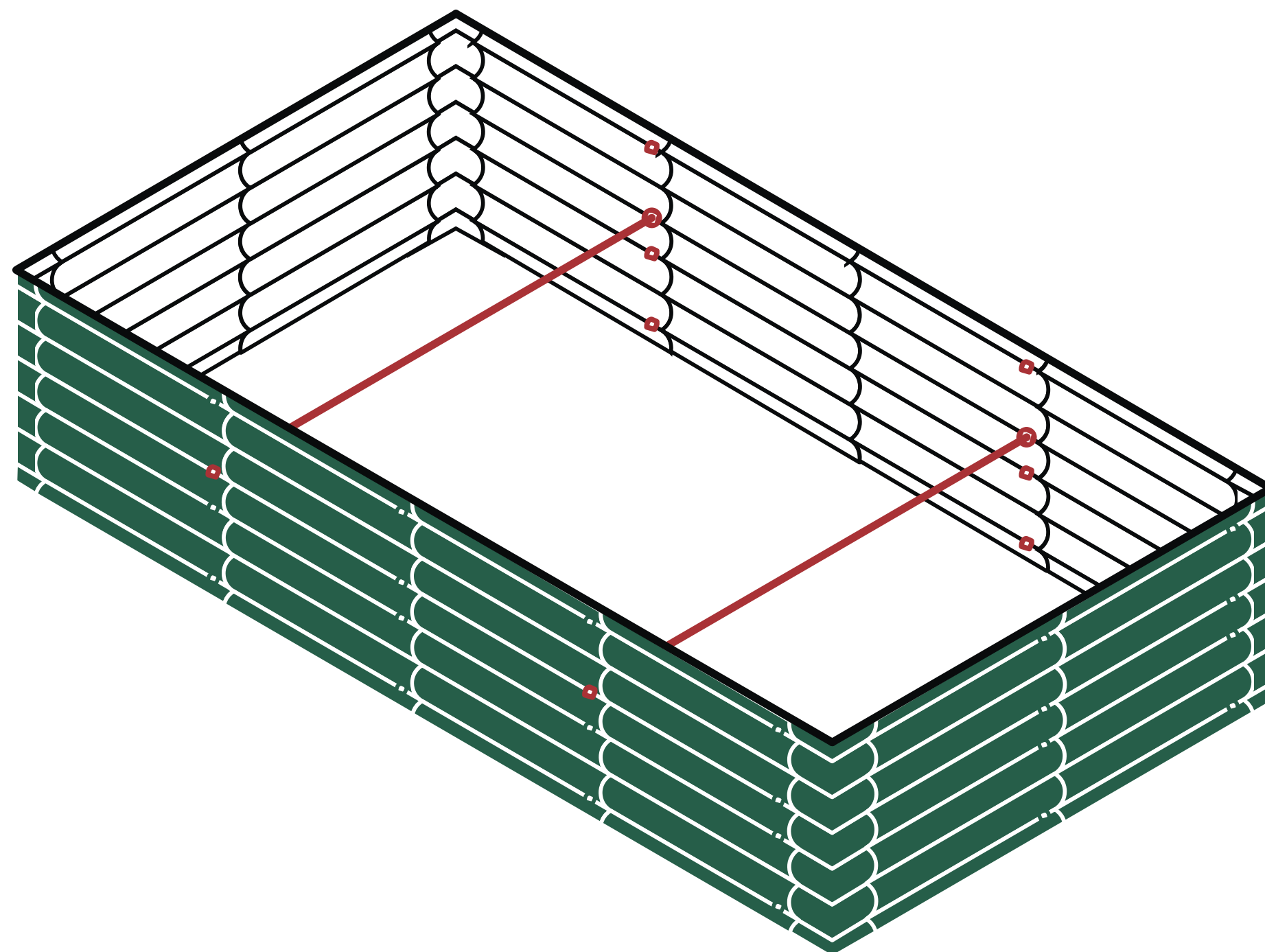

17 in.H × 6.5 ft.L × 3.5
ft.W Bracing Rod: 2 ×
(2+1.5)ft

ASSEMBLY INSTRUCTION

BRACING RODS PLACING

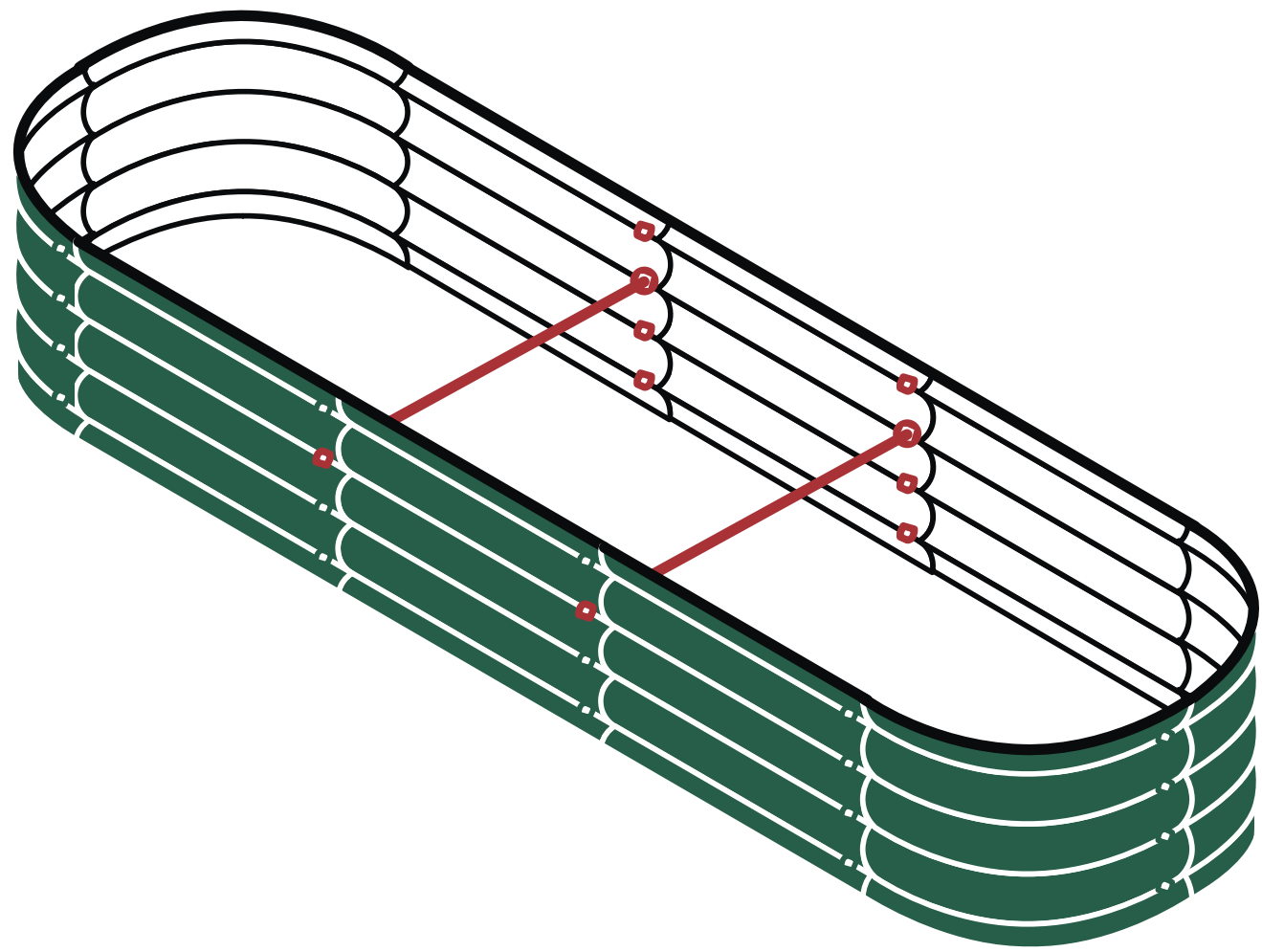

11 in.H × 6.5 ft.L × 2 ft.W
Bracing Rod: 2 × 2ft

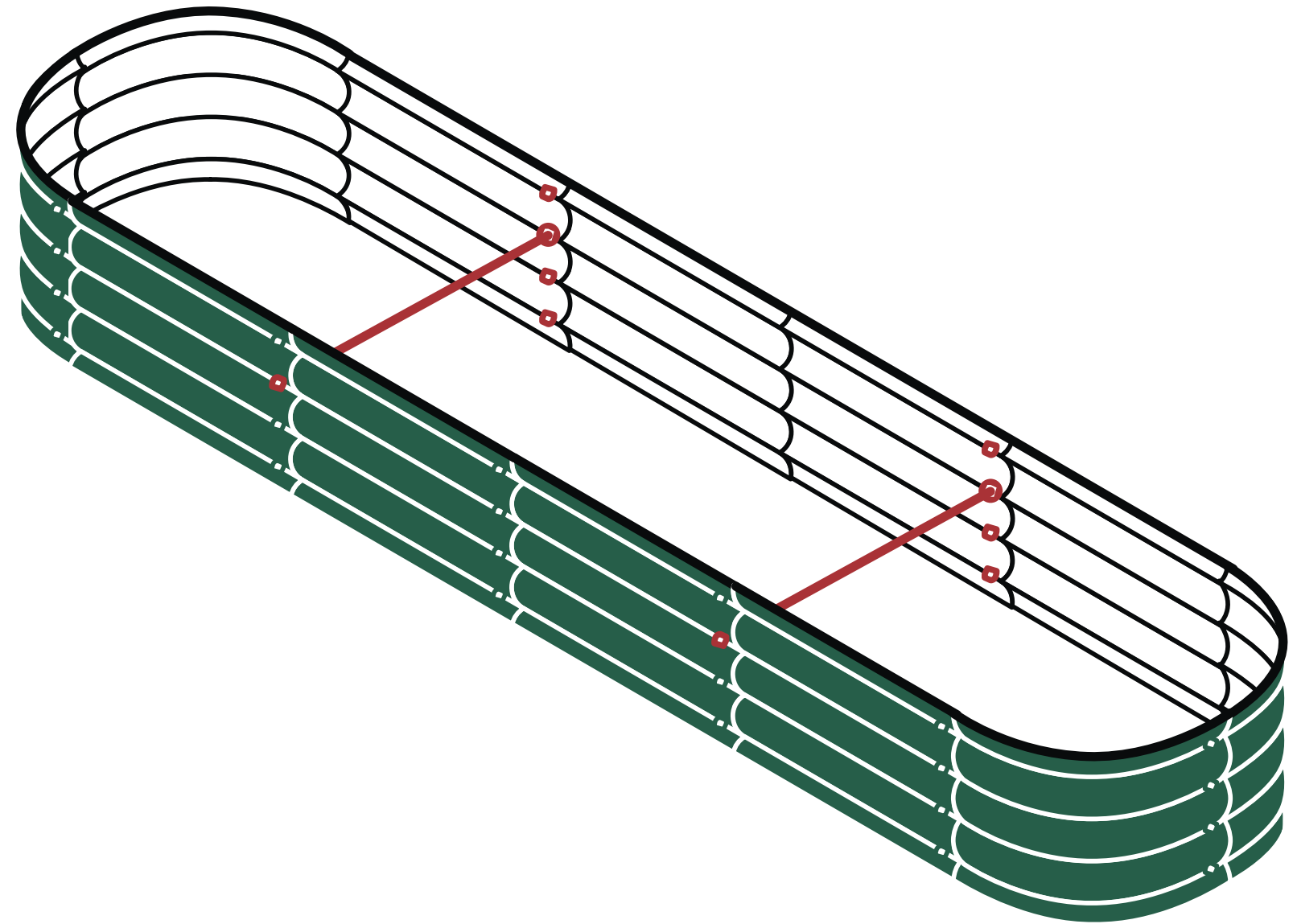

11 in.H × 8 ft.L × 2 ft.W
Bracing Rod: 2 × 2ft

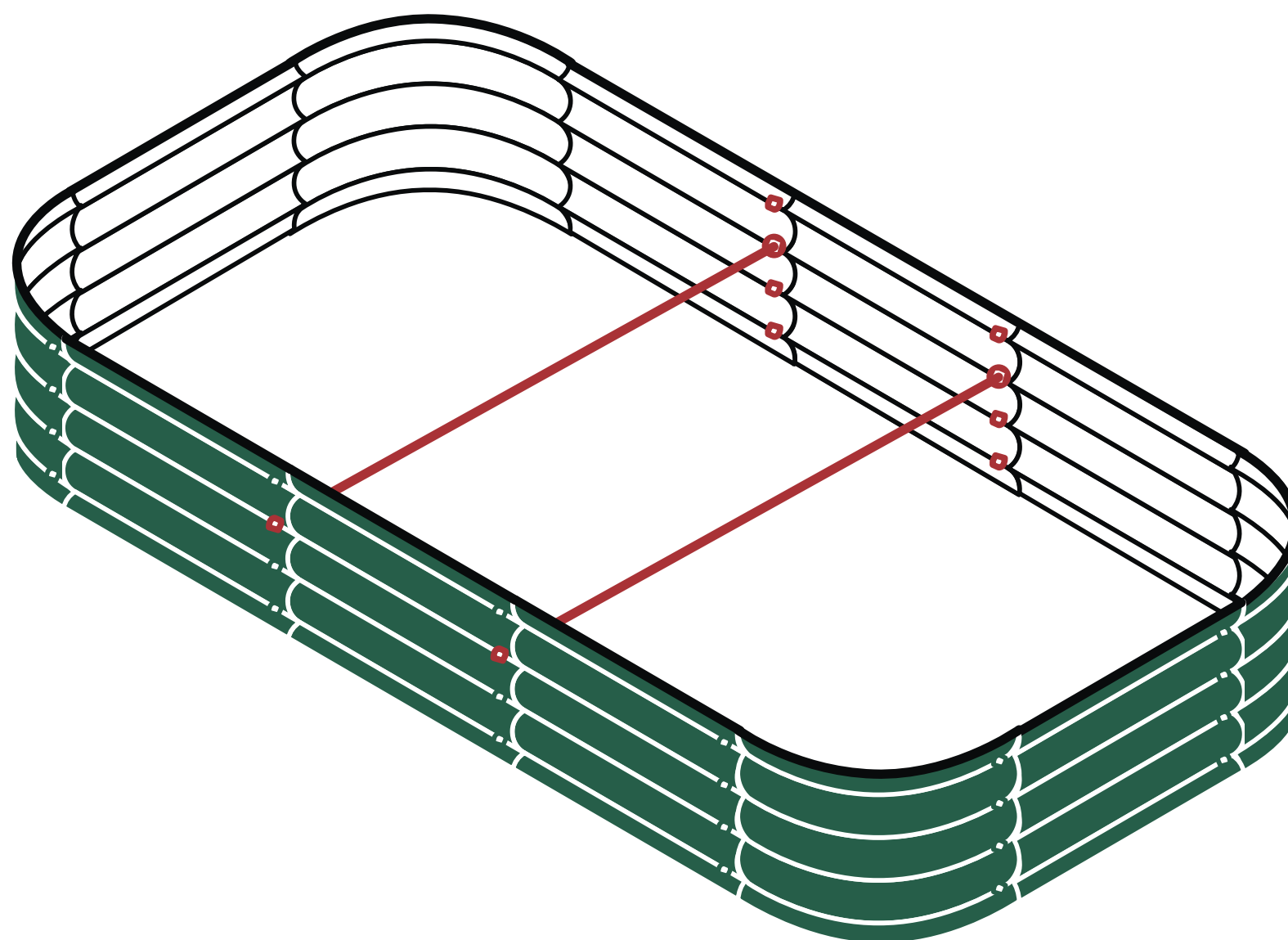

11 in.H × 6.5 ft.L × 3.5
ft.W Bracing Rod: 2 ×
(2+1.5)ft

ASSEMBLY INSTRUCTION

BRACING RODS PLACING

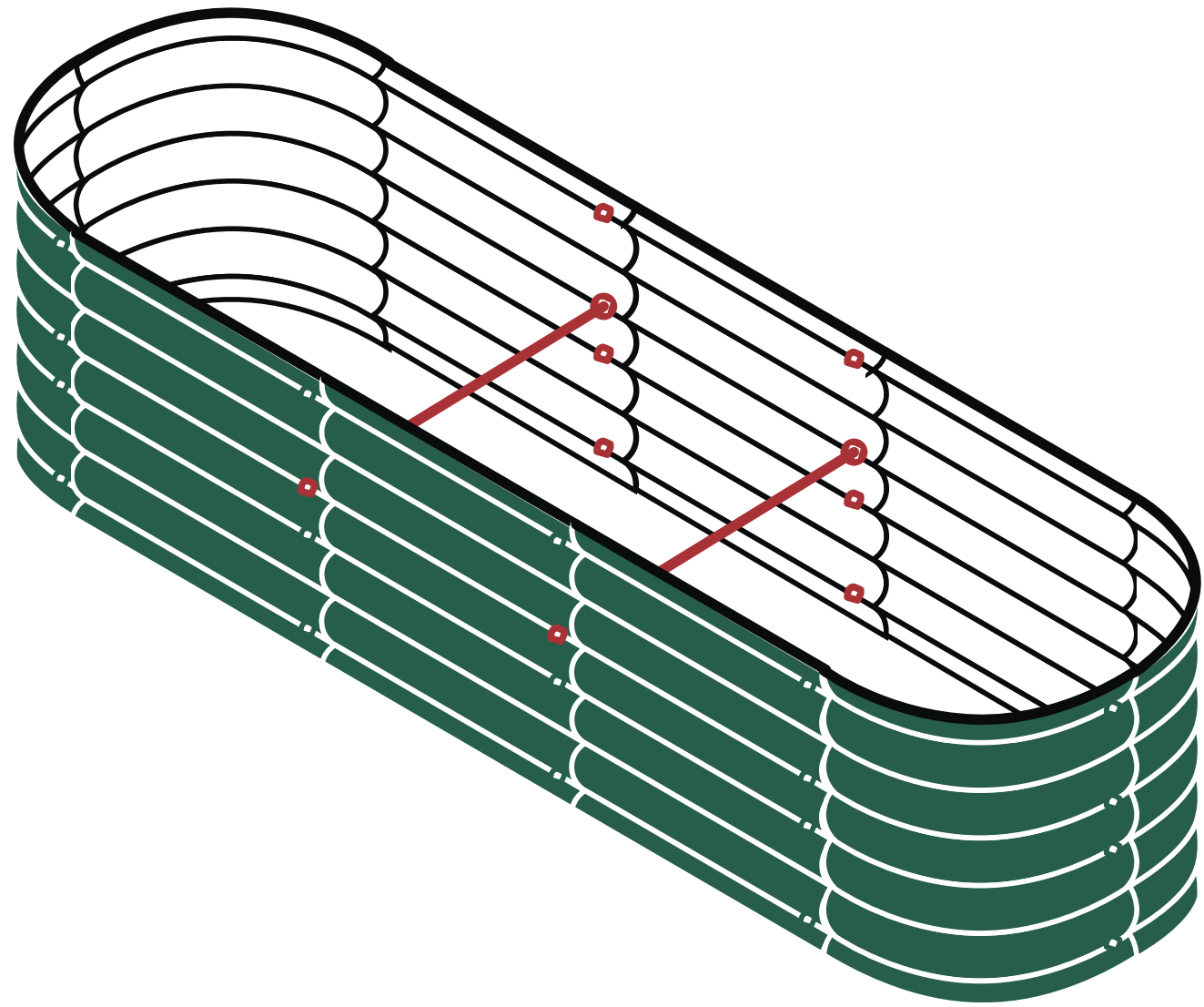

17 in.H × 6.5 ft.L × 2 ft.W
Bracing Rod: 2 × 2ft

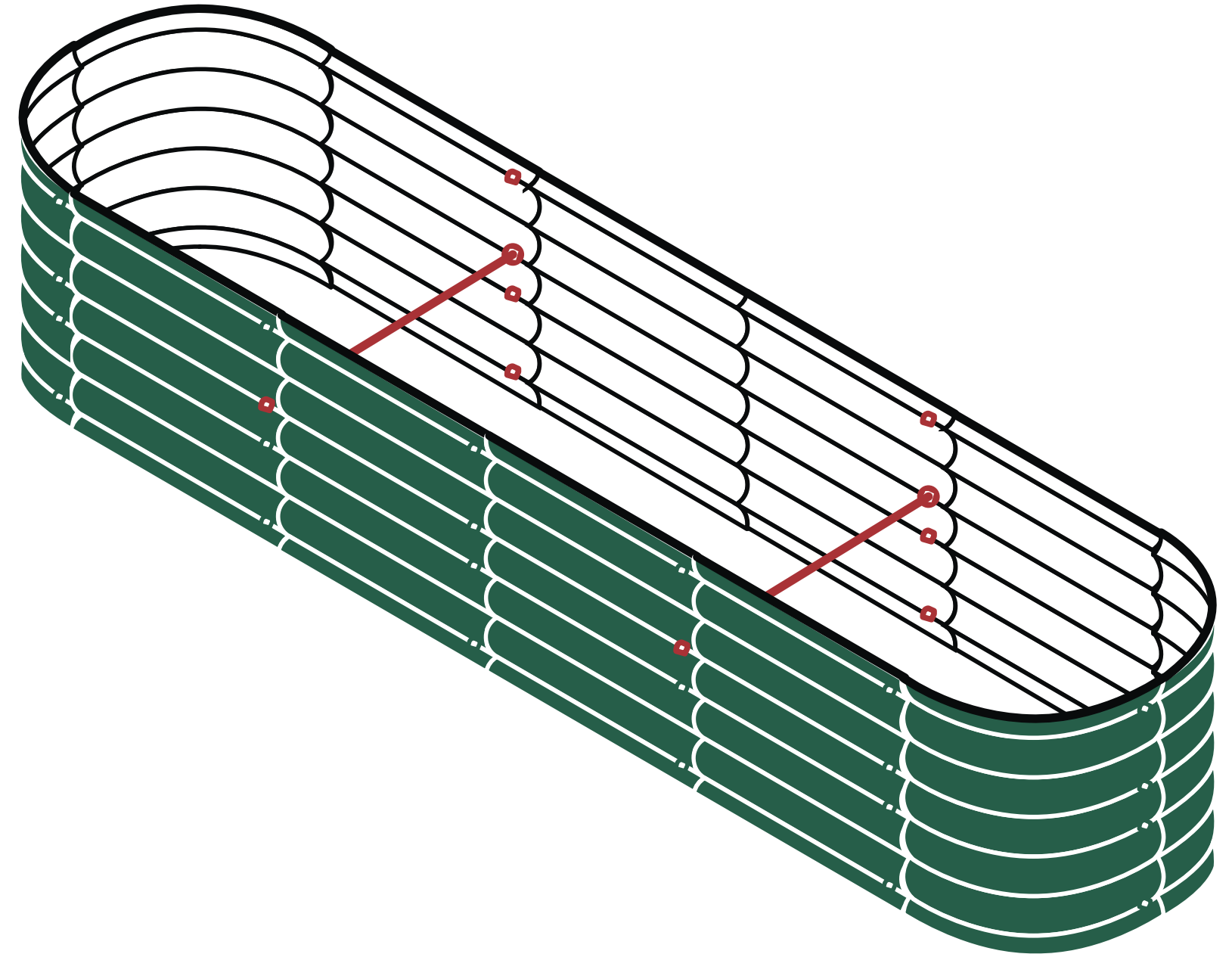

17 in.H × 8 ft.L × 2 ft.W
Bracing Rod: 2 × 2ft

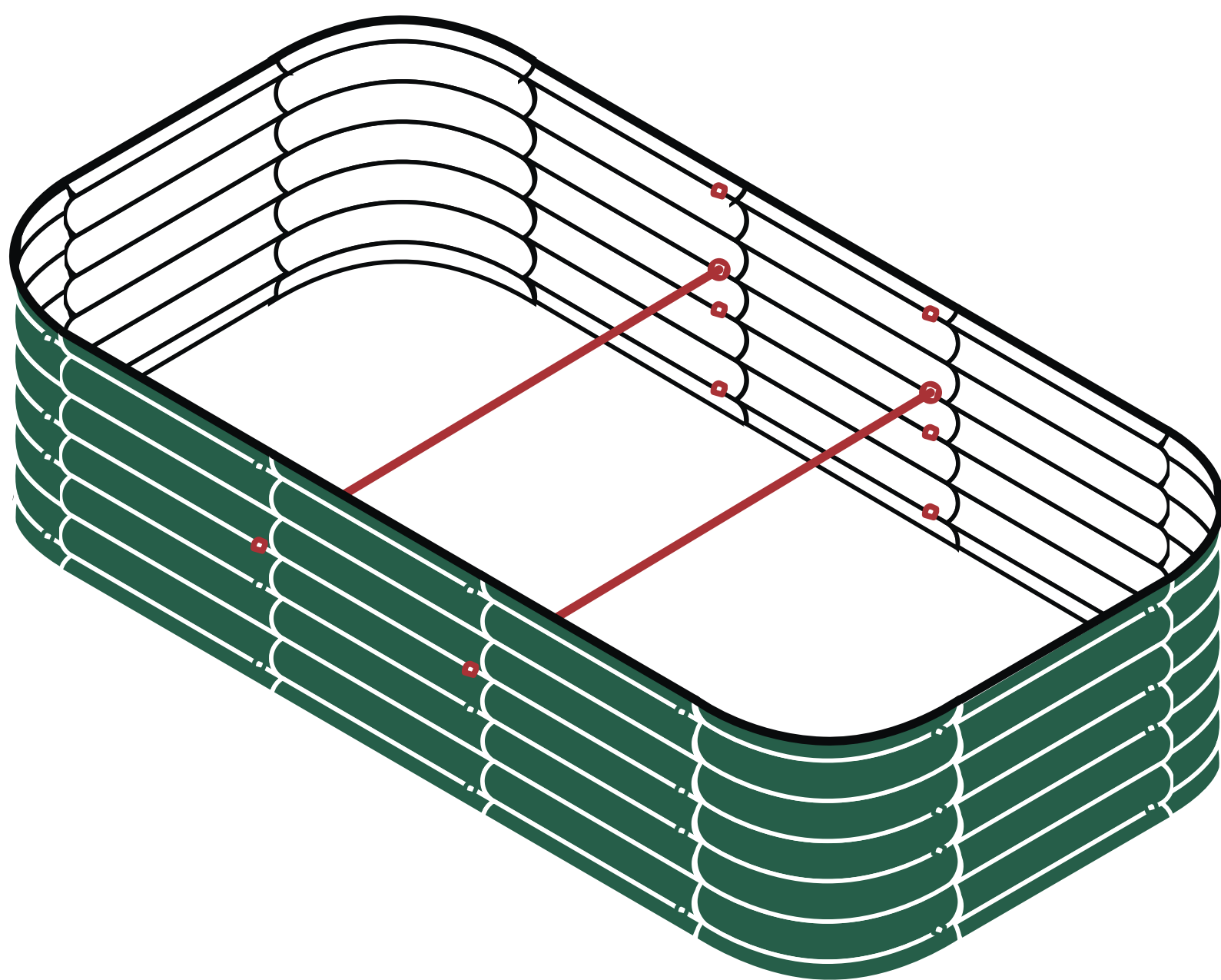

17 in.H × 6.5 ft.L × 3.5
ft.W Bracing Rod: 2 ×
(2+1.5)ft

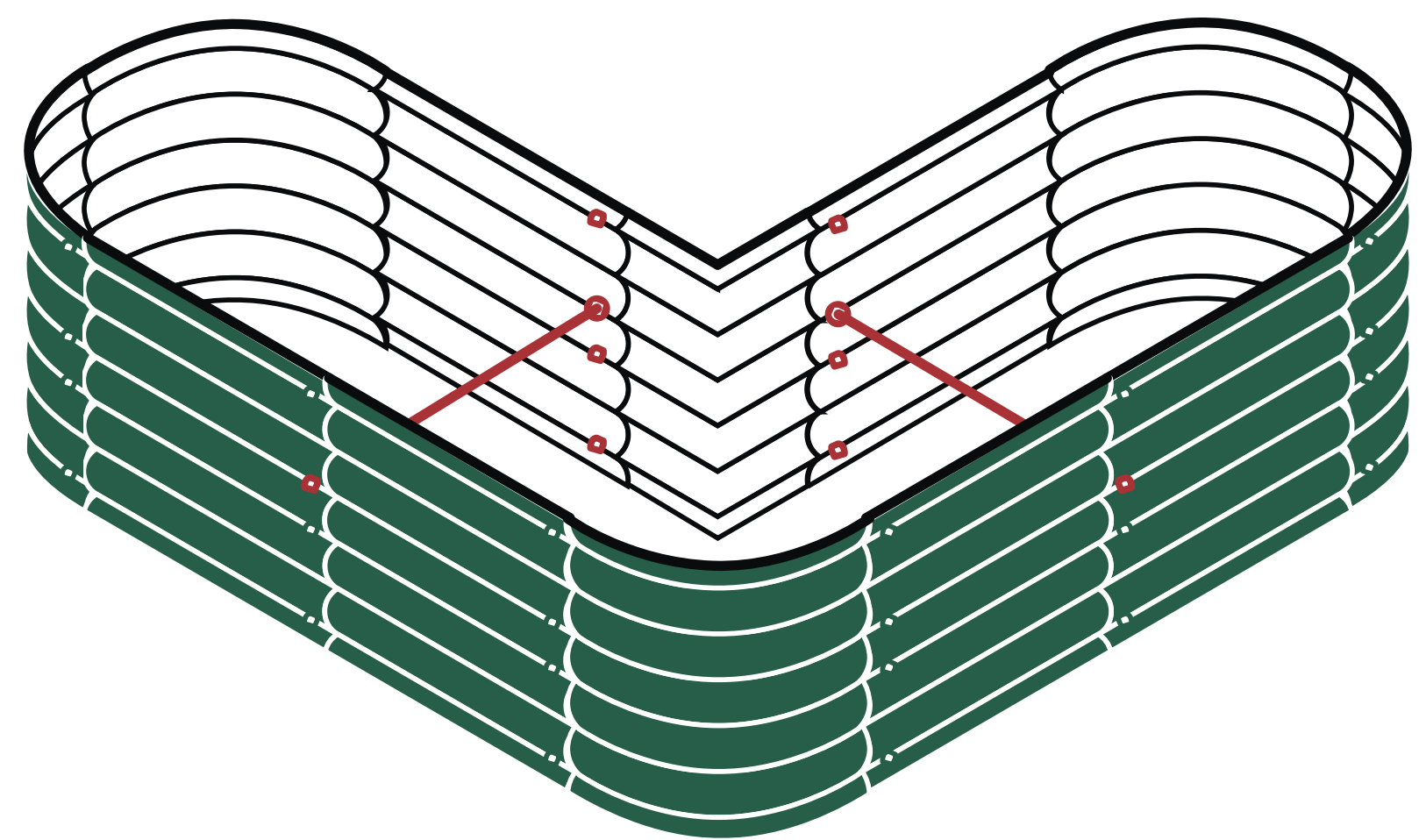

17 in.H × 5.5 ft.L × 5.5
ft.W Bracing Rod: 2 × 2.5ft

ASSEMBLY INSTRUCTION

BRACING RODS PLACING

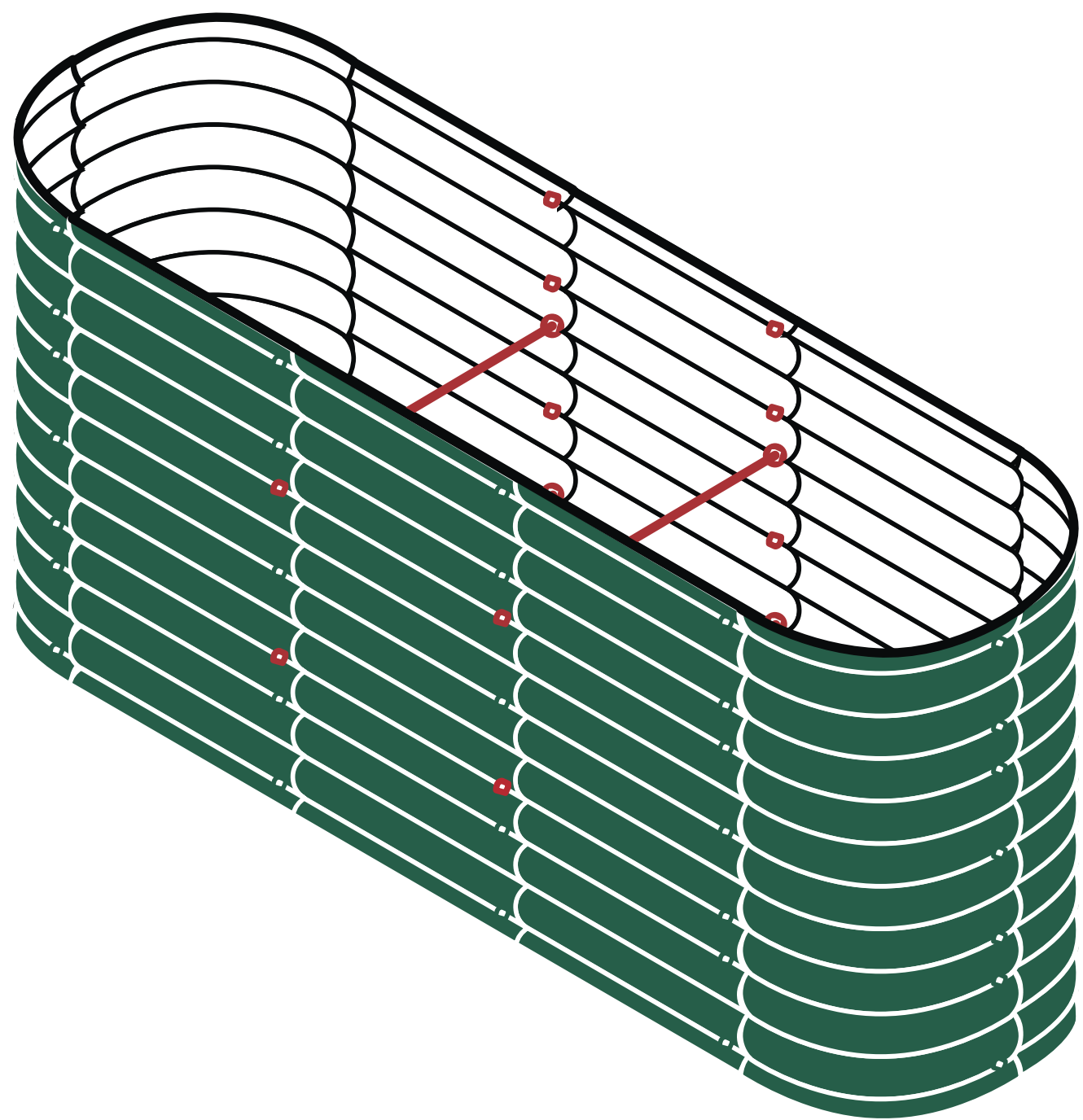

32 in.H × 6.5 ft.L × 2 ft.W
Bracing Rod: 4 × 2ft

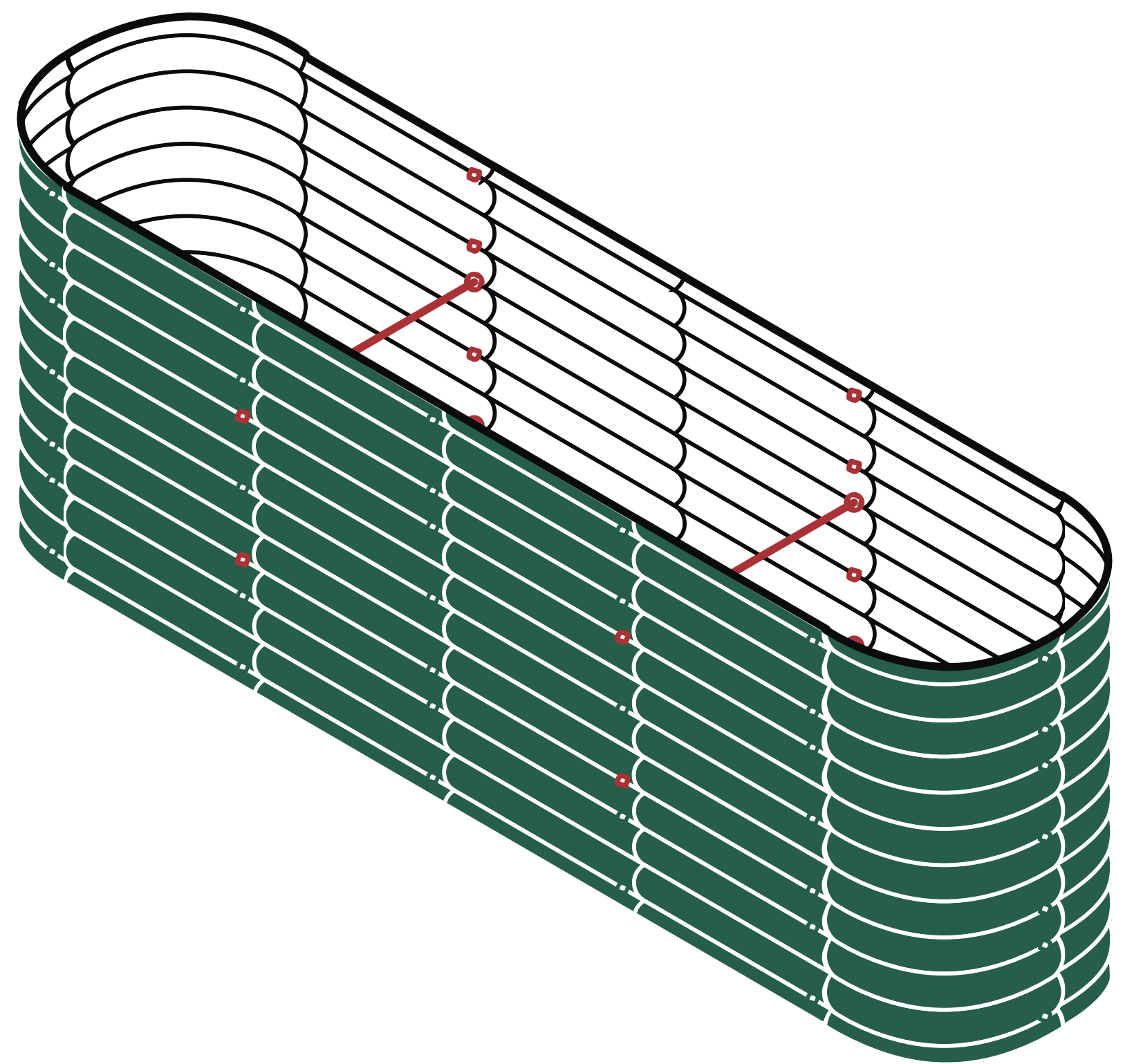

32 in.H × 8 ft.L × 2 ft.W
Bracing Rod: 4 × 2ft

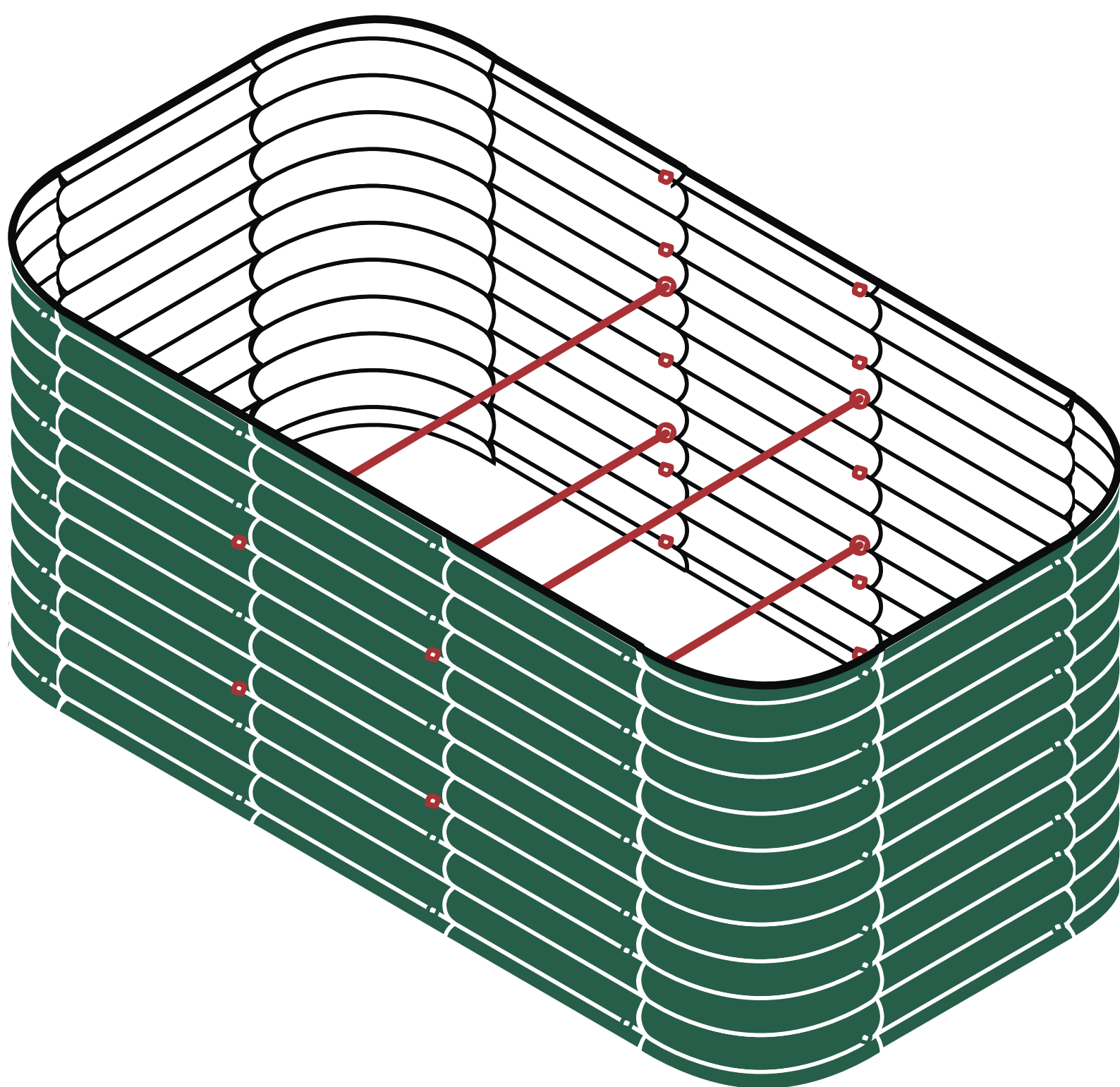

32 in.H × 6.5 ft.L × 3.5 ft.W
Bracing Rod: 4 × (2+1.5)ft

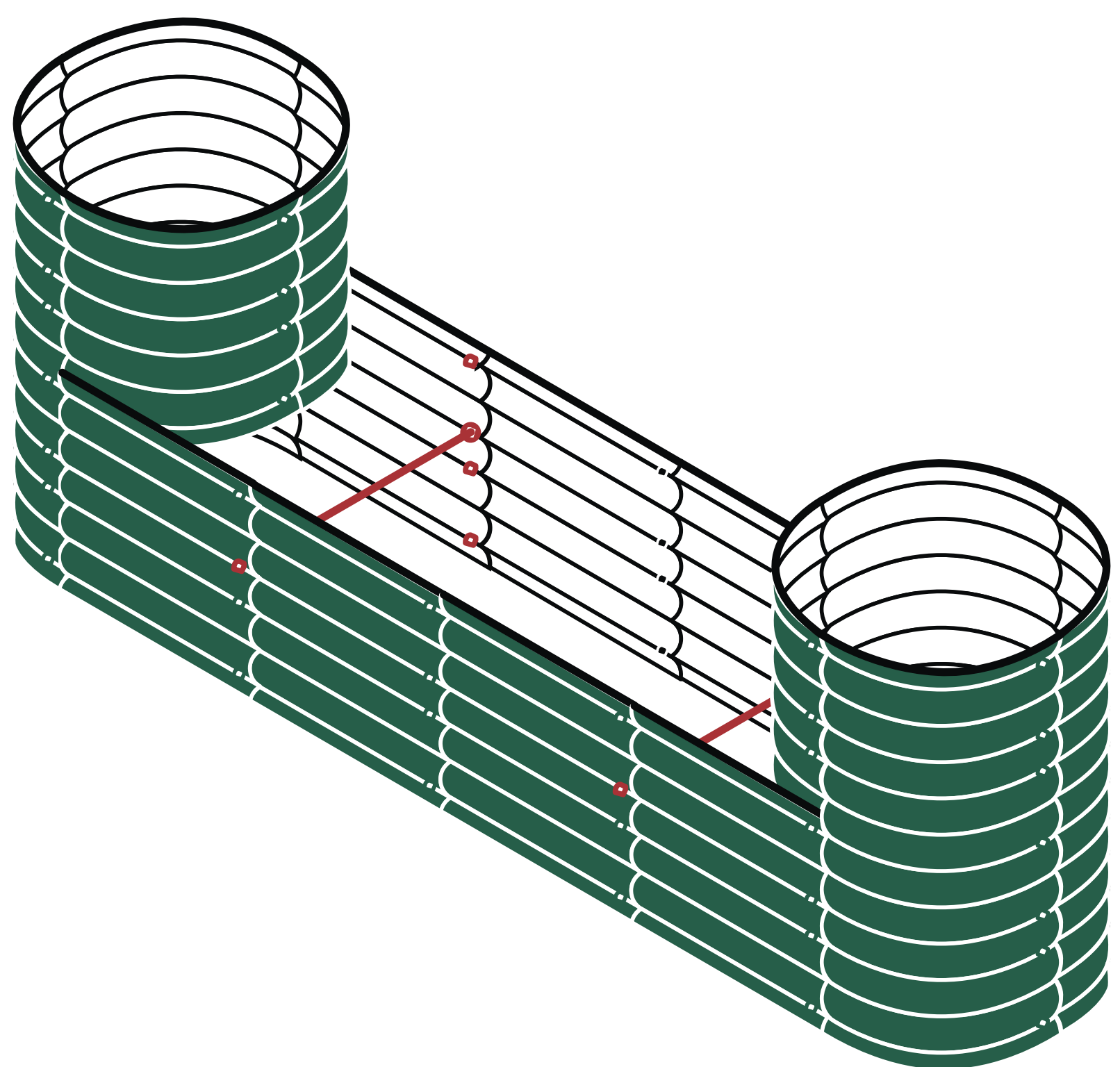

32 in.H × 8 ft.L × 2 ft.W
Bracing Rod: 2 × 2ft

ASSEMBLY INSTRUCTION

BRACING RODS PLACING

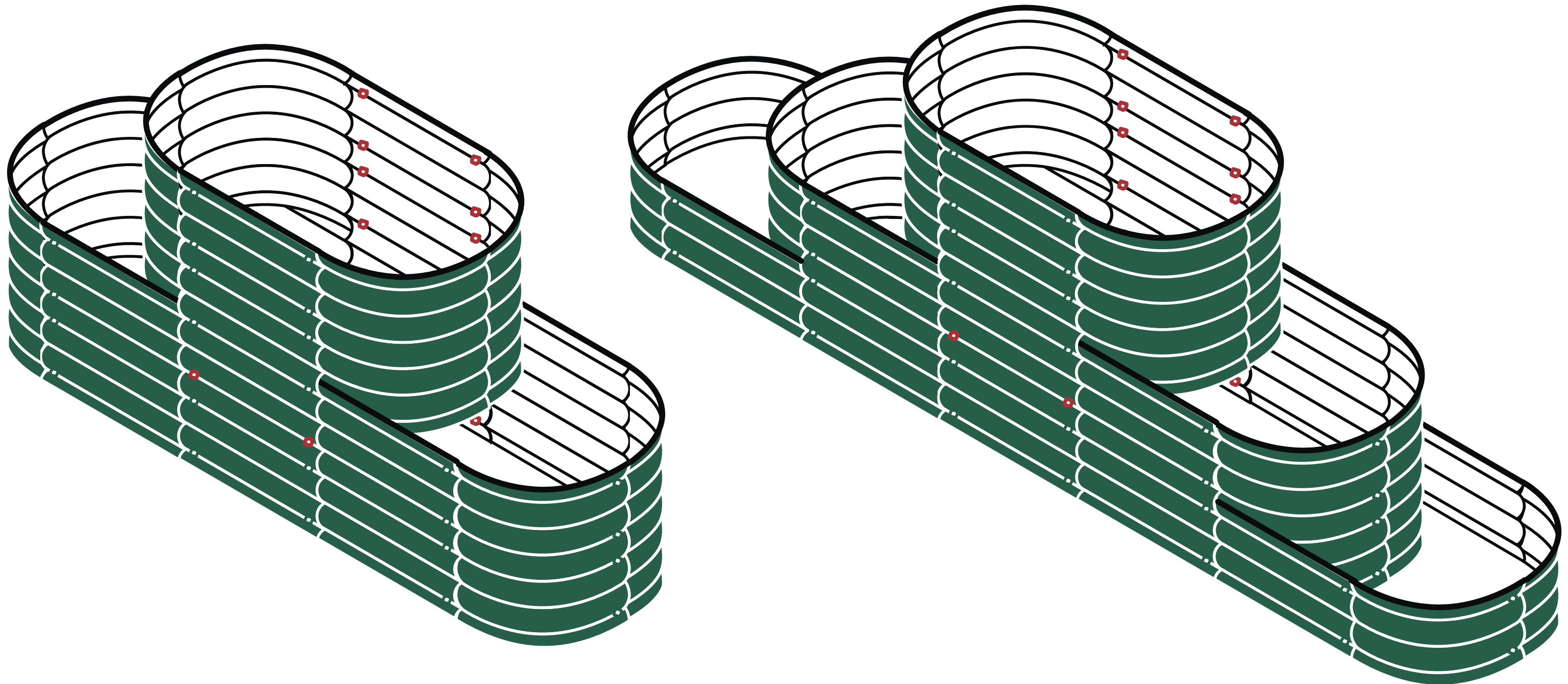

32 in.H × 6.5 ft.L × 2 ft.W Bracing Rod: 2 × 2ft

32 in.H × 9.5 ft.L × 2 ft.W Bracing Rod: 2 × 2ft

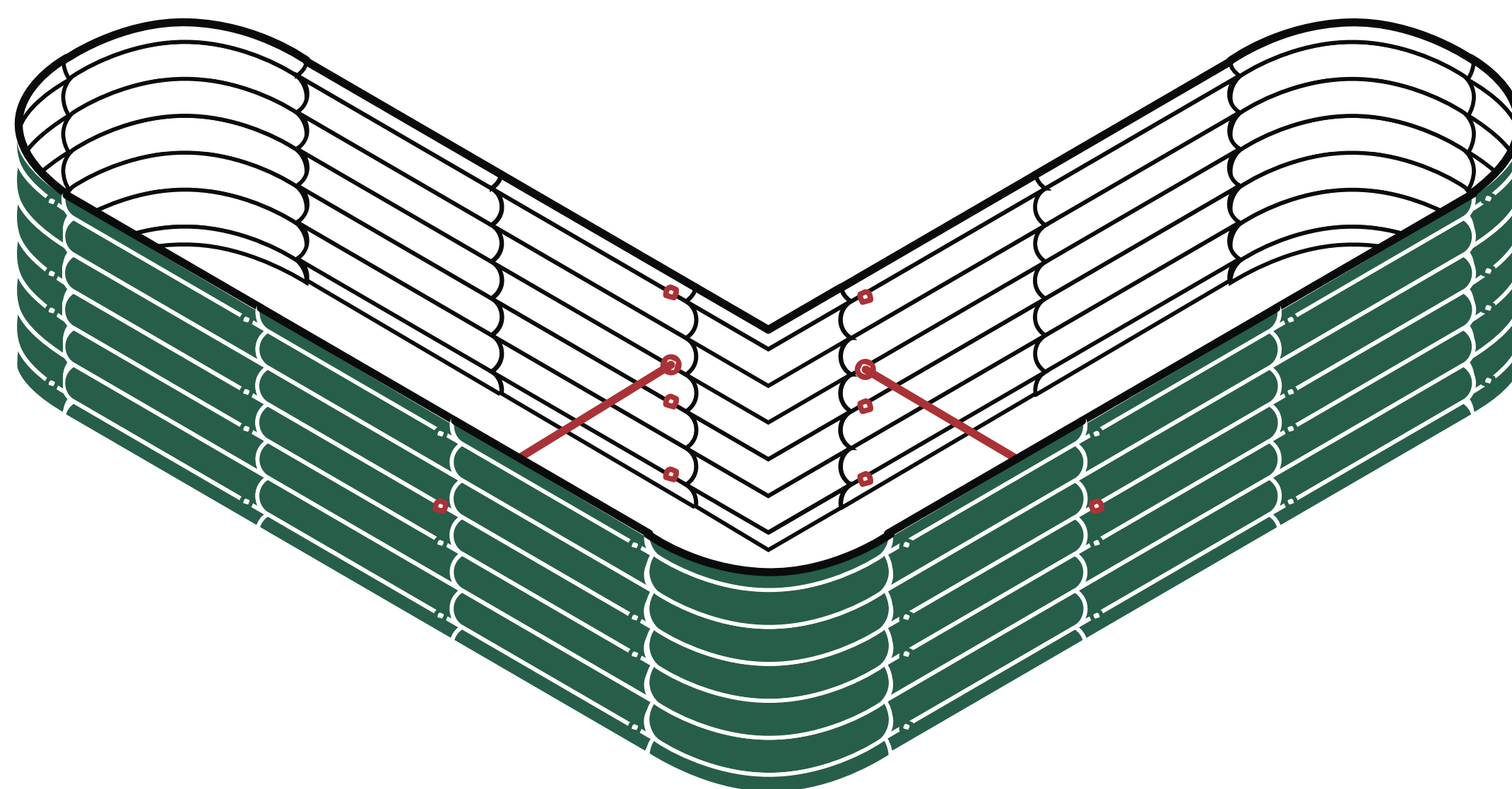

17 in.H × 7 ft.L × 7 ft.W
Bracing Rod: 2 × 2.5ft

ASSEMBLY INSTRUCTION

BRACING RODS PLACING

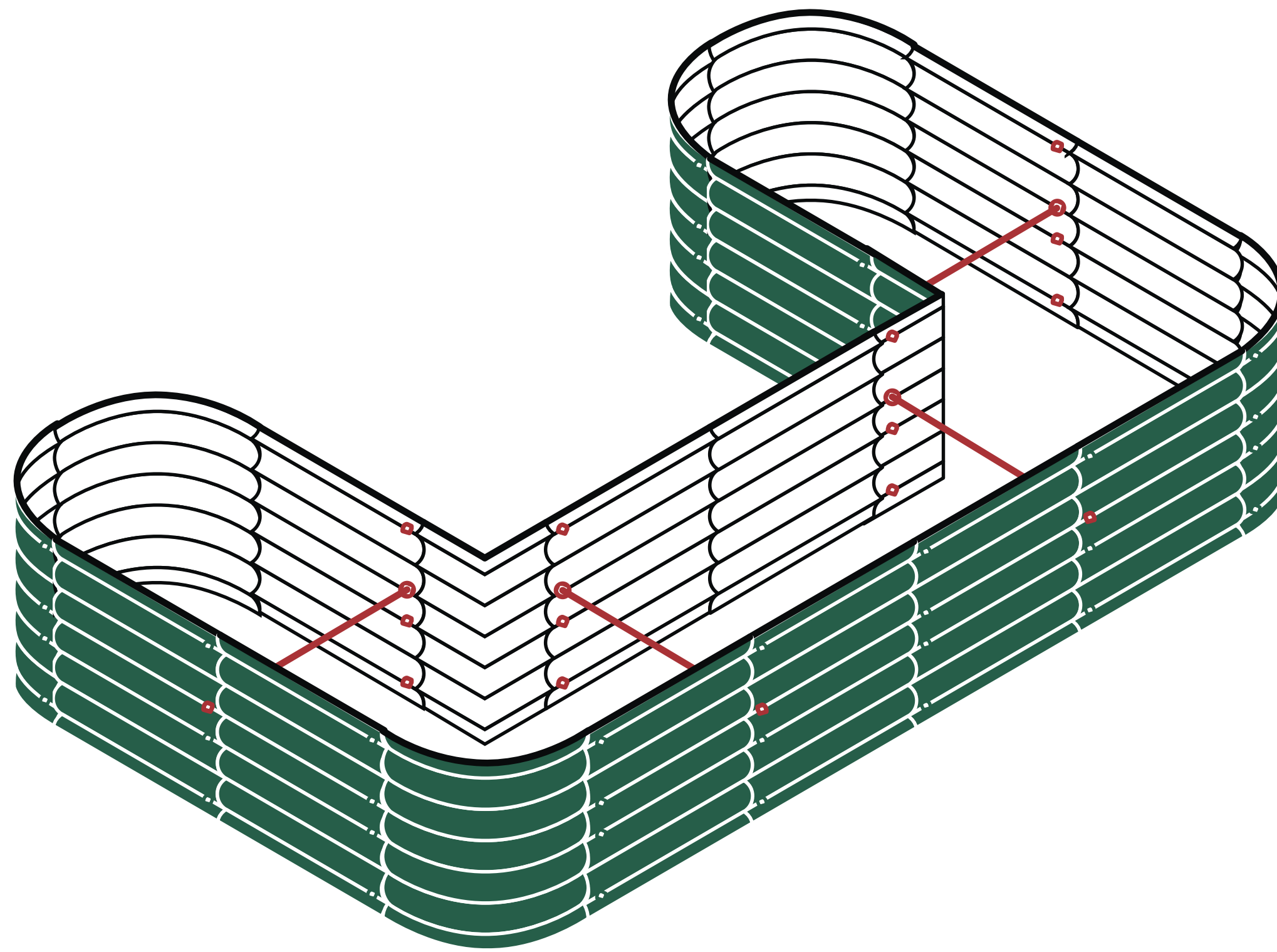

17 in.H × 8.5 ft.L × 5.5
ft.W Bracing Rod: 4 × 2.5ft

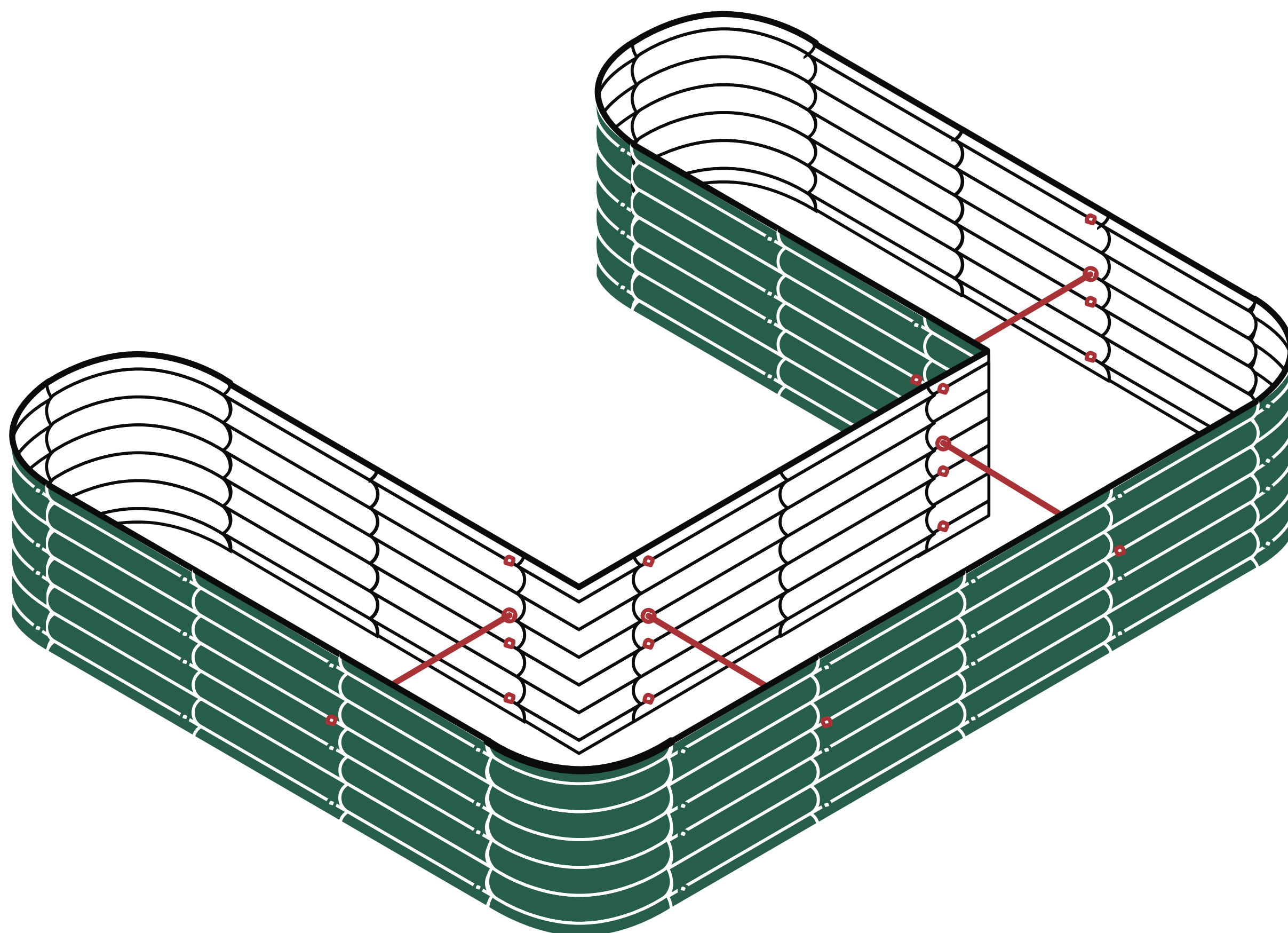

17 in.H × 8.5 ft.L × 7 ft.W
Bracing Rod: 4 × 2.5ft



GardenBee™

DripWorks®

 Quality Drip Systems Since 1991



support@dripworks.com



190 Sanhedrin Circle Willits,
CA 95490



1-800-522-3747
Mon-Fri, 9am To 2pm PST

The Garden of Knowledge

Scan the QR code to
dive into our blog for
expert gardening tips,
hacks, and green
inspiration. Join our
community!



dripworks.com